

# A Century of Numerical Weather Prediction: The View from Limerick

*Peter Lynch*

*Peter.Lynch@ucd.ie*

*Meteorology & Climate Centre, University College Dublin*

**Seminar**

**Dept. of Mathematics & Statistics**

**University of Limerick**

# The Pre-history of Numerical Weather Prediction (*circa* 1900)

Vilhelm Bjerknes, Max Margules and Lewis Fry Richardson

# Vilhelm Bjerknes (1862–1951)



Vilhelm Bjerknes on the quay at Bergen, painted by Rolf Groven, 1983

# Vilhelm Bjerknes (1862–1951)

- Born in March, 1862.
- Matriculated in 1880.
- **Fritjøf Nansen** was a fellow-student.
- Paris, 1889–90.
  - Studied under **Poincaré**.
- Bonn, 1890–92.
  - Worked with **Heinrich Hertz**.
- Worked in Stockholm, 1893–1907.
- 1898: Circulation theorems published
- **1904: Meteorological Manifesto**
- Christiania (Oslo), 1907–1912.
- Leipzig, 1913–1917.
- Bergen, 1917–1926.
- **1919: Frontal Cyclone Model.**
  - Oslo, 1926 — 1951. Retired 1937. Died, April 9, 1951.

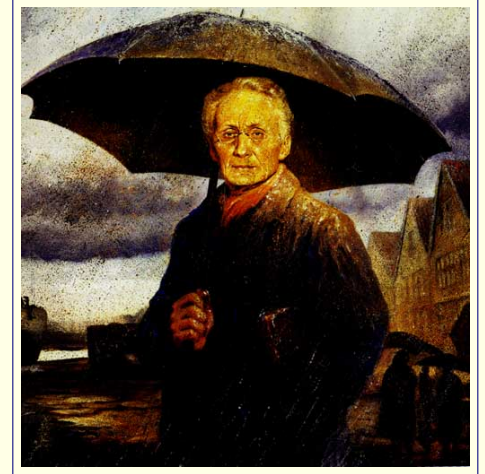

Vilhelm Bjerknes

# Bjerknes' 1904 Manifesto

To establish a science of meteorology, with the aim of predicting future states of the atmosphere from the present state.

“If it is true ... that atmospheric states develop according to physical law, then ... the conditions for the rational solution of forecasting problems are:

# Bjerknes' 1904 Manifesto

To establish a science of meteorology, with the aim of predicting future states of the atmosphere from the present state.

“If it is true ... that atmospheric states develop according to physical law, then ... the conditions for the rational solution of forecasting problems are:

1. An accurate knowledge of the state of the atmosphere at the initial time.



# Bjerknes' 1904 Manifesto

To establish a science of meteorology, with the aim of predicting future states of the atmosphere from the present state.

“If it is true ... that atmospheric states develop according to physical law, then ... the conditions for the rational solution of forecasting problems are:

1. An accurate knowledge of the state of the atmosphere at the initial time.
2. An accurate knowledge of the physical laws according to which one state ... develops from another.”

# Bjerknes' 1904 Manifesto

To establish a science of meteorology, with the aim of predicting future states of the atmosphere from the present state.

“If it is true ... that atmospheric states develop according to physical law, then ... the conditions for the rational solution of forecasting problems are:

1. An accurate knowledge of the state of the atmosphere at the initial time.
2. An accurate knowledge of the physical laws according to which one state ... develops from another.”

Step (1) is Diagnostic.

Step (2) is Prognostic.



# Graphical v. Numerical Approach

Bjerknes ruled out **analytical solution** of the mathematical equations, due to their nonlinearity and complexity:

“For the solution of the problem in this form, **graphical or mixed graphical and numerical methods** are appropriate, which methods must be derived either from the partial differential equations or from the dynamical-physical principles which are the basis of these equations.”

The First Reading from

**The Book of Limerick**

The First Reading from

# The Book of Limerick

**Bill Bjerknes** defined, with **conviction**,  
The science of weather **prediction**:

The First Reading from

# The Book of Limerick

Bill Bjerknes defined, with conviction,  
The science of weather prediction:  
By chart diagnosis,  
And graphic prognosis,

# The First Reading from

## The Book of Limerick

Bill Bjerknes defined, with conviction,  
The science of weather prediction:  
By chart diagnosis,  
And graphic prognosis,  
The forecast is rendered non-fiction.

# The *Impossibility* of Forecasting

In 1904, **Max Margules** contributed a short paper for the *Festschrift* published to mark the sixtieth birthday of his former teacher, the renowned physicist **Ludwig Boltzmann**.

Über die Beziehung zwischen Barometerschwankungen und Kontinuitätsgleichung. *Boltzmann-Festschrift*, Leipzig.

Margules considered the possibility of **predicting pressure changes** by means of the continuity equation.

# The *Impossibility* of Forecasting

In 1904, **Max Margules** contributed a short paper for the *Festschrift* published to mark the sixtieth birthday of his former teacher, the renowned physicist **Ludwig Boltzmann**.

Über die Beziehung zwischen Barometerschwankungen und Kontinuitätsgleichung. *Boltzmann-Festschrift*, Leipzig.

Margules considered the possibility of **predicting pressure changes** by means of the continuity equation.

He showed that, to obtain an accurate estimate of the pressure tendency, the winds would have to be known to a precision quite beyond the practical limit.

He concluded that any attempt to forecast synoptic changes by this means was **doomed to failure**.



# The *Impossibility* of Forecasting

In 1904, **Max Margules** contributed a short paper for the *Festschrift* published to mark the sixtieth birthday of his former teacher, the renowned physicist **Ludwig Boltzmann**.

Über die Beziehung zwischen Barometerschwankungen und Kontinuitätsgleichung. *Boltzmann-Festschrift*, Leipzig.

Margules considered the possibility of **predicting pressure changes** by means of the continuity equation.

He showed that, to obtain an accurate estimate of the pressure tendency, the winds would have to be known to a precision quite beyond the practical limit.

He concluded that any attempt to forecast synoptic changes by this means was **doomed to failure**.

A translation of Margules' 1904 paper, together with a short introduction, has been published as a Historical Note by Met Éireann.

# The *Vienna School*

Many outstanding scientists were active in meteorological studies in Austria in the period 1890–1925, and great progress was made in dynamic and synoptic meteorology and in climatology during this time.

Julius Hann

Josef Pernter

Wilhelm Trabert

Felix Exner

Wilhelm Schmidt

Heinrich Ficker

Albert Defant

**Max Margules**

# Max Margules (1856–1920)



Photograph from the archives of Zentralanstalt für  
Meteorologie und Geodynamik, Wien.

Margules was born in the town of Brody, in western Ukraine, in 1856.

He studied mathematics and physics at Vienna University, and among his teachers was Ludwig Boltzmann.

In 1882 he joined the Meteorological Institute as an Assistant, and continued to work there for 24 years.

# Some of Margules' Achievements

Margules studied the diurnal and semi-diurnal variations in atmospheric pressure due to solar radiative forcing.

He derived two species of solutions of the Laplace tidal equations, which he called *Wellen erster Art* and *Wellen zweiter Art*

This was the first identification of the distinct types of waves now known as *inertia-gravity waves* and *rotational waves*.



# Some of Margules' Achievements

Margules studied the diurnal and semi-diurnal variations in atmospheric pressure due to solar radiative forcing.

He derived two species of solutions of the Laplace tidal equations, which he called *Wellen erster Art* and *Wellen zweiter Art*

This was the first identification of the distinct types of waves now known as *inertia-gravity waves* and *rotational waves*.

★ ★ ★

Margules showed that the available potential energy associated with **horizontal temperature contrasts** within a midlatitude cyclone was sufficient to explain the observed winds.

This work suggested that there were sloping frontal surfaces associated with mid-latitude depressions, and foreshadowed the frontal theory which emerged about a decade later.

# A Meteorological Tragedy

Margules was an introverted and lonely man, who never married and worked in isolation, not collaborating with other scientists.

He was disappointed and disillusioned at the lack of recognition of his work and retired from the Meteorological Institute in 1906, aged only fifty, on a modest pension.

# A Meteorological Tragedy

Margules was an introverted and lonely man, who never married and worked in isolation, not collaborating with other scientists.

He was disappointed and disillusioned at the lack of recognition of his work and retired from the Meteorological Institute in 1906, aged only fifty, on a modest pension.

Its value was severely eroded during the First World War so that his 400 crowns per month was worth about one Euro, insufficient for more than the most meagre survival.

His colleagues tried their best to help him, making repeated offers of help which Margules resolutely resisted.



# A Meteorological Tragedy

Margules was an introverted and lonely man, who never married and worked in isolation, not collaborating with other scientists.

He was disappointed and disillusioned at the lack of recognition of his work and retired from the Meteorological Institute in 1906, aged only fifty, on a modest pension.

Its value was severely eroded during the First World War so that his 400 crowns per month was worth about one Euro, insufficient for more than the most meagre survival.

His colleagues tried their best to help him, making repeated offers of help which Margules resolutely resisted.

*He died of starvation in 1920.*

# A Layer of Incompressible Fluid

The physical principle of mass conservation is expressed mathematically in terms of the continuity equation

$$\frac{\partial \rho}{\partial t} + \nabla \cdot \rho \mathbf{V} = 0$$

★      ★      ★

# A Layer of Incompressible Fluid

The physical principle of mass conservation is expressed mathematically in terms of the continuity equation

$$\frac{\partial \rho}{\partial t} + \nabla \cdot \rho \mathbf{V} = 0$$

★            ★            ★

Under hydrostatic balance the pressure at a point is determined by **the weight of air above it.**

# A Layer of Incompressible Fluid

The physical principle of mass conservation is expressed mathematically in terms of the continuity equation

$$\frac{\partial \rho}{\partial t} + \nabla \cdot \rho \mathbf{V} = 0$$

★            ★            ★

Under hydrostatic balance the pressure at a point is determined by **the weight of air above it**.

We can replace the atmosphere by an **incompressible fluid layer** of finite depth. We take the density to be numerically equal to one (i.e.,  $\rho = 1 \text{ kg m}^{-3}$ , comparable to air).

Then, if the depth is ten kilometres (or  $h = 10^4 \text{ m}$ ), the pressure is  $p = \rho gh = 1 \times 10 \times 10^4 = 10^5 \text{ Pa} = 1 \text{ atm}$ .

In other words, this ten-kilometre layer of incompressible fluid of unit density gives rise to a **surface pressure similar to that of the compressible atmosphere**.

We consider a square geographical region of side 10 km:

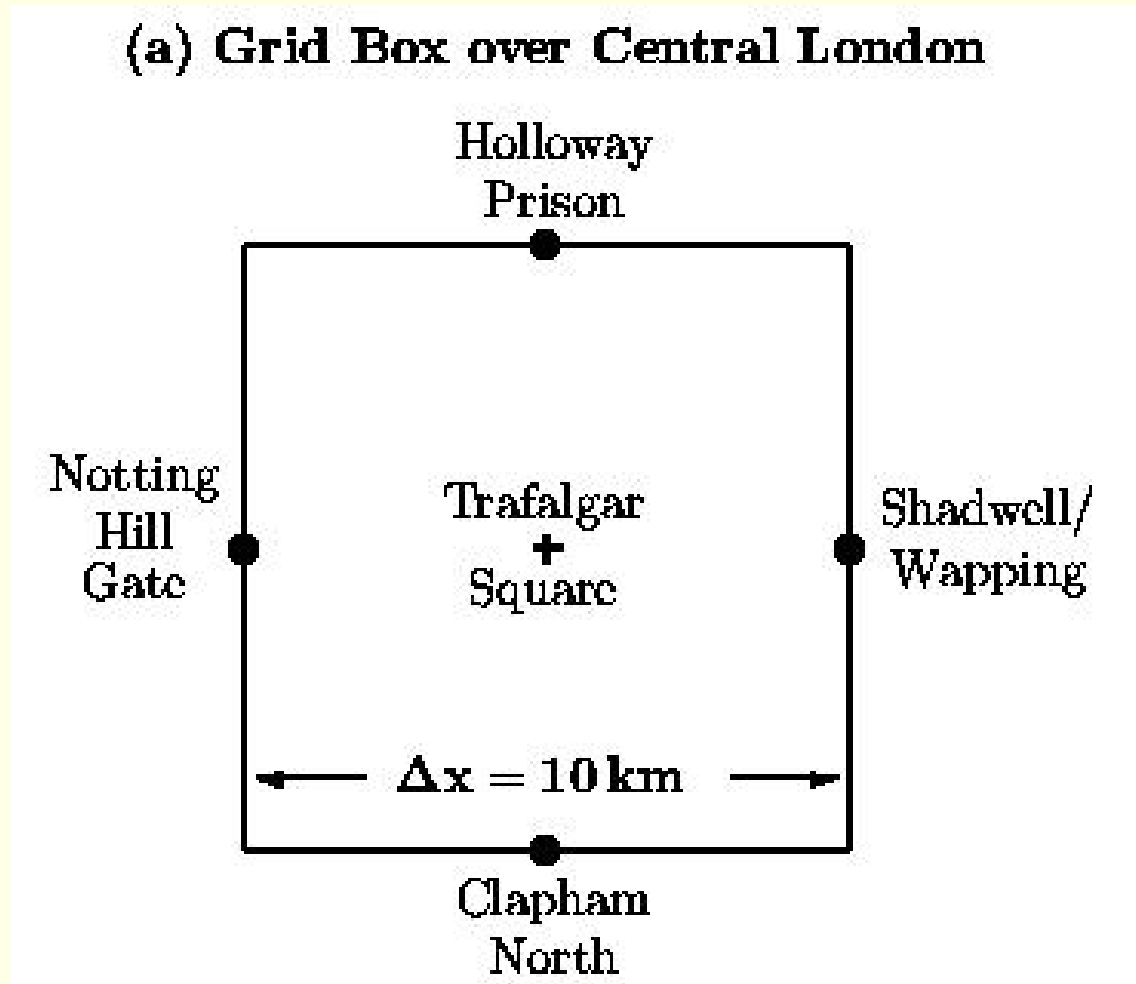

The area of the region is  $10^8$  square metres.

The column of fluid above this square forms a cube whose volume is the area multiplied by the depth:

$$V = 10^8 \times 10^4 = 10^{12} \text{ m}^3$$

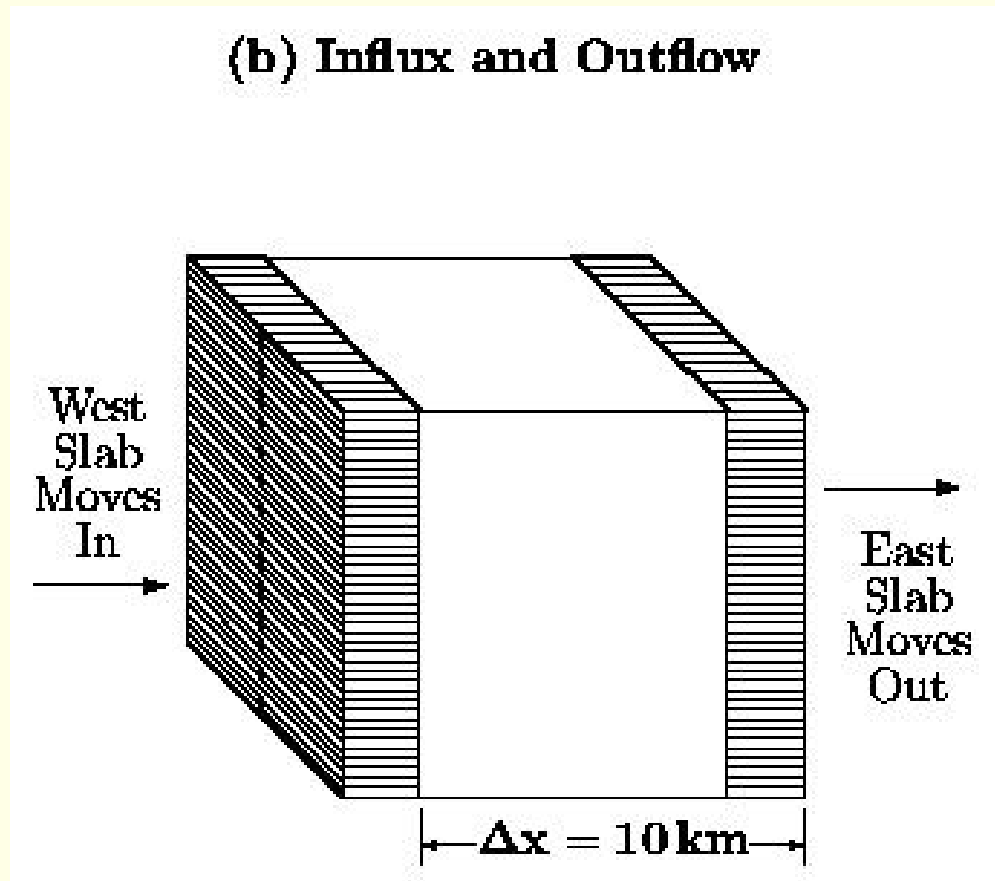

The total mass of fluid contained in the cube (in kg) has the same *numerical* value as the volume:

$$M = 10^{12} \text{ kg} = 1000 \text{ megatonnes}$$

# Convergence and Divergence

How does the pressure at a point change?



# Convergence and Divergence

## How does the pressure at a point change?

Since pressure is due to the weight of fluid above the point in question, *the only way it can change is through fluxes of air into or out of the column above the point.*

Nett inward and outward fluxes are respectively called *convergence* and *divergence*.

# Convergence and Divergence

## How does the pressure at a point change?

Since pressure is due to the weight of fluid above the point in question, *the only way it can change is through fluxes* of air into or out of the column above the point.

Nett inward and outward fluxes are respectively called *convergence* and *divergence*.

A difficulty arises because the *nett* convergence or divergence is **a small difference between two large numbers.**



# Convergence and Divergence

## How does the pressure at a point change?

Since pressure is due to the weight of fluid above the point in question, *the only way it can change is through fluxes* of air into or out of the column above the point.

Nett inward and outward fluxes are respectively called *convergence* and *divergence*.

A difficulty arises because the *nett* convergence or divergence is **a small difference between two large numbers**.

★ ★ ★

Suppose that the movement of air is from west to east, so that no air flows through the north or south faces of our cubic column.

Assume for now that the wind speed has a **uniform value of ten metres per second**.

**(c) Influx = Outflow**

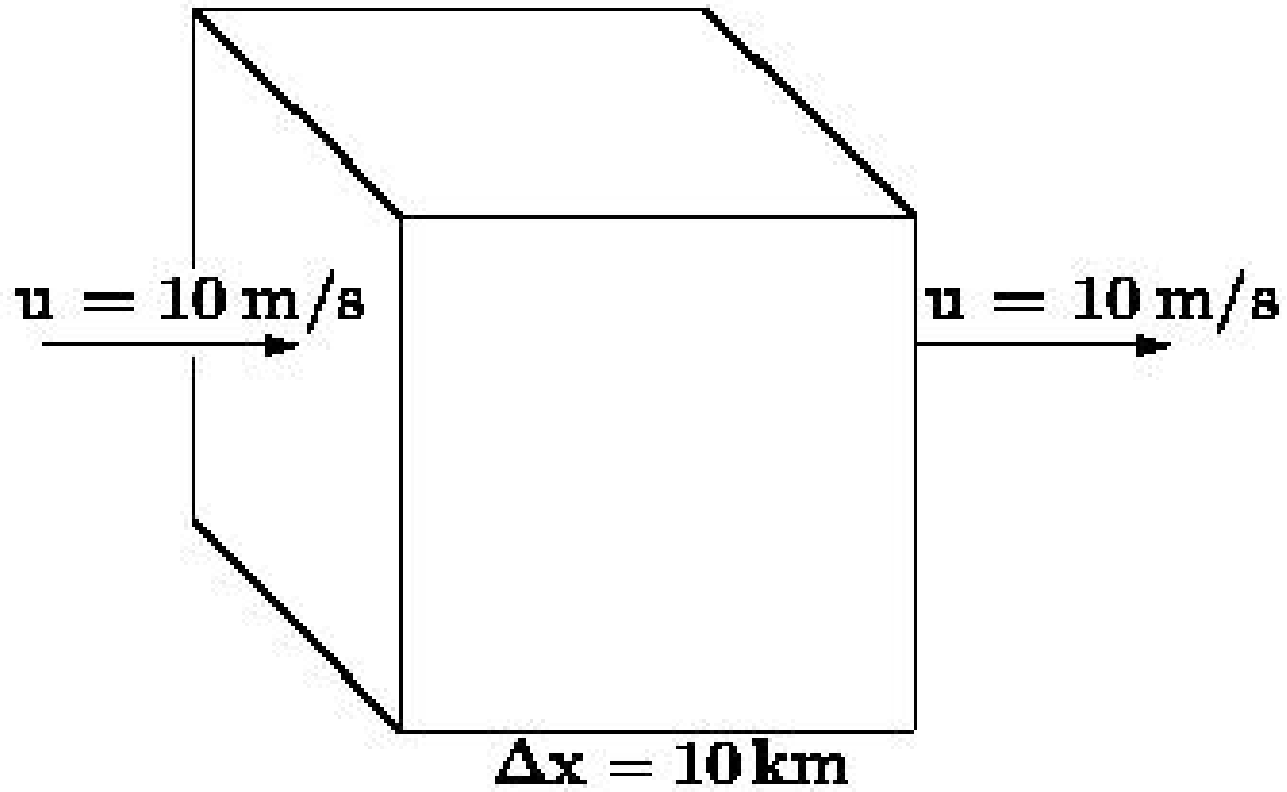

**(c) Influx = Outflow**

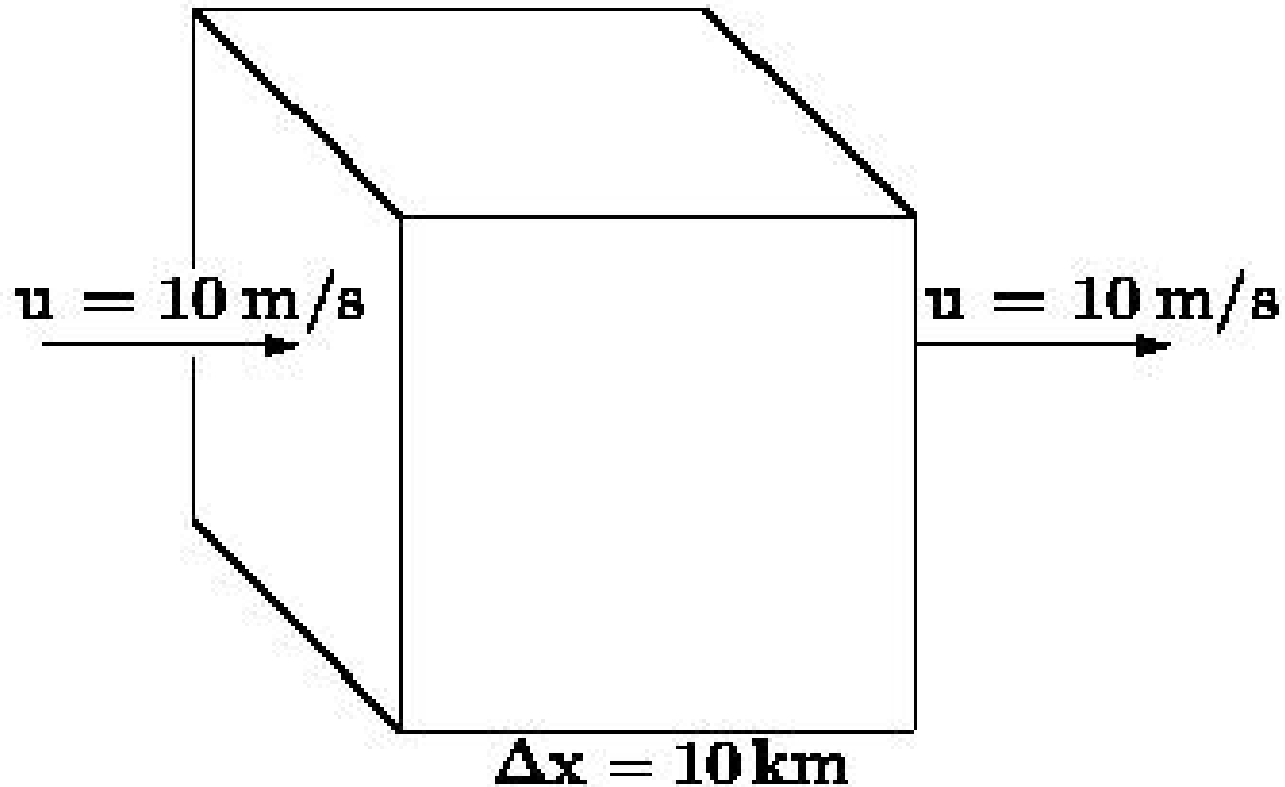

Thus, in a single second, a slab of air of lateral extend 10 km, of height 10 km and of thickness ten metres, moves into the cube through its western face

The slab of air moving into the cube has volume

$$V_{\text{in}} = 10^9 \text{ m}^3$$

Its mass has the same *numerical* value (since  $\rho = 1$ ):

$$M_{\text{in}} = 10^9 \text{ kg}$$

So the mass of the cube would increase by  $10^9$  kg, or *one megatonne per second* **if there were only inward flux.**

The slab of air moving into the cube has volume

$$V_{\text{in}} = 10^9 \text{ m}^3$$

Its mass has the same *numerical* value (since  $\rho = 1$ ):

$$M_{\text{in}} = 10^9 \text{ kg}$$

So the mass of the cube would increase by  $10^9$  kg, or *one megatonne per second* **if there were only inward flux.**

However, there is a corresponding **flux of air outward** through the eastern face of the cube, with precisely the same value.

So, the *nett* flux is zero:

$$(\text{Flux})_{\text{in}} = (\text{Flux})_{\text{out}}$$

The total mass of air in the cube is unchanged, and the **surface pressure remains constant.**



Now suppose that the flow speed inward through the western face of the cube is **slightly greater**, let us say 1% greater:

$$u_{\text{in}} = 10.1 \text{ m s}^{-1}, \quad u_{\text{out}} = 10.0 \text{ m s}^{-1}$$

Now suppose that the flow speed inward through the western face of the cube is **slightly greater**, let us say 1% greater:

$$u_{\text{in}} = 10.1 \text{ m s}^{-1}, \quad u_{\text{out}} = 10.0 \text{ m s}^{-1}$$

There is thus **more fluid flowing into the cube than out**. There is a ***nett convergence*** of mass into the cube.

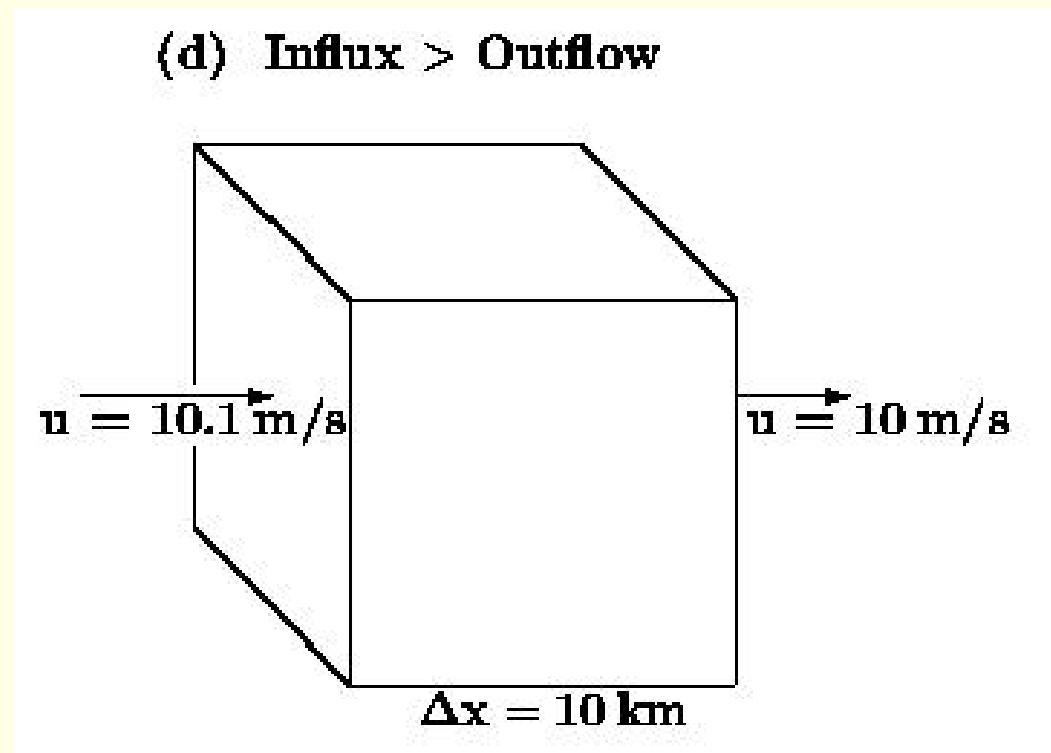

Now suppose that the flow speed inward through the western face of the cube is **slightly greater**, let us say 1% greater:

$$u_{\text{in}} = 10.1 \text{ m s}^{-1}, \quad u_{\text{out}} = 10.0 \text{ m s}^{-1}$$

There is thus **more fluid flowing into the cube than out**. There is a **net convergence** of mass into the cube.

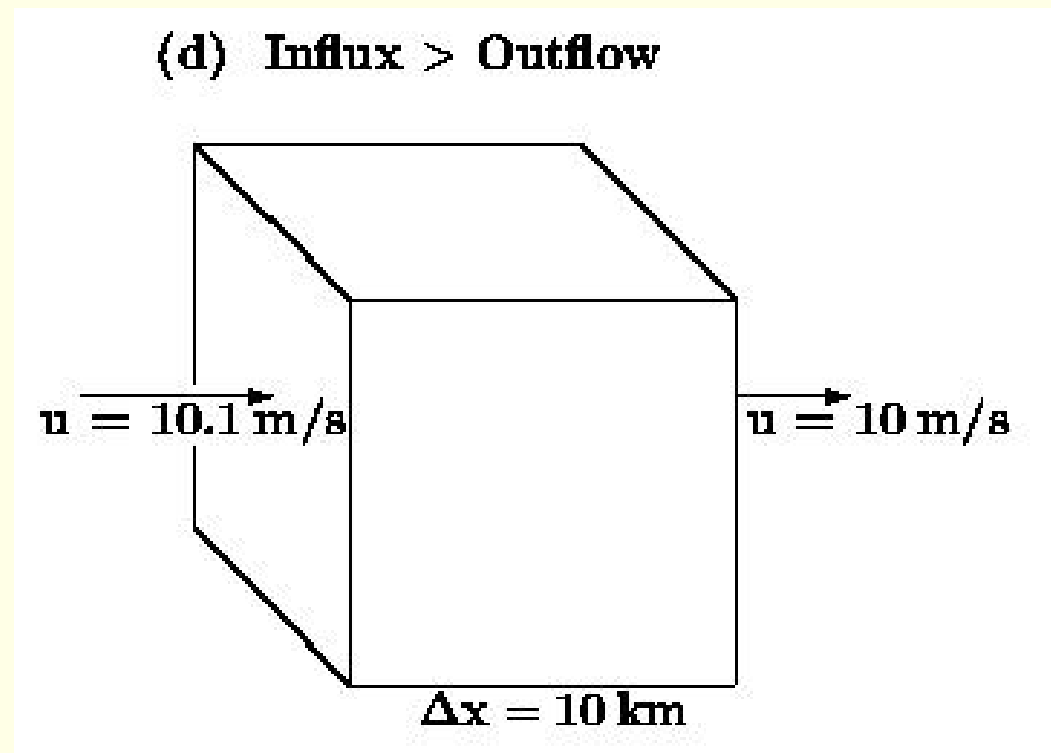

We may expect a pressure rise. **Let us now calculate it.**

The **additional inward flux** of mass is 1% of the total inward flux:

$$\Delta(\text{Flux})_{\text{in}} = 0.01 \times 10^9 = 10^7 \text{ kg s}^{-1}$$

Initially, the total mass of the cube was  $M = 10^{12}$  kg, so the *fractional increase in mass* in one second is

$$\frac{\Delta M}{M} = \frac{10^7}{10^{12}} = 10^{-5}$$

The **additional inward flux** of mass is 1% of the total inward flux:

$$\Delta(\text{Flux})_{\text{in}} = 0.01 \times 10^9 = 10^7 \text{ kg s}^{-1}$$

Initially, the total mass of the cube was  $M = 10^{12}$  kg, so the *fractional increase in mass* in one second is

$$\frac{\Delta M}{M} = \frac{10^7}{10^{12}} = 10^{-5}$$

Pressure is proportional to mass. Therefore, the *fractional increase in pressure* is precisely the same.

To get the *rate of increase in pressure*, we multiply the total pressure by this ratio:

$$\frac{dp}{dt} = \frac{\Delta M}{M} \times p = 10^{-5} \times 10^5 = 1 \text{ Pa s}^{-1}$$

The **additional inward flux** of mass is 1% of the total inward flux:

$$\Delta(\text{Flux})_{\text{in}} = 0.01 \times 10^9 = 10^7 \text{ kg s}^{-1}$$

Initially, the total mass of the cube was  $M = 10^{12}$  kg, so the *fractional increase in mass* in one second is

$$\frac{\Delta M}{M} = \frac{10^7}{10^{12}} = 10^{-5}$$

Pressure is proportional to mass. Therefore, the *fractional increase in pressure* is precisely the same.

To get the *rate of increase in pressure*, we multiply the total pressure by this ratio:

$$\frac{dp}{dt} = \frac{\Delta M}{M} \times p = 10^{-5} \times 10^5 = 1 \text{ Pa s}^{-1}$$

The rate of pressure increase is **one Pascal per second**.

A pressure tendency of  $1 \text{ Pa s}^{-1}$  may not sound impressive but, if sustained over a long period of time, it is **dramatic**.

A pressure tendency of  $1 \text{ Pa s}^{-1}$  may not sound impressive but, if sustained over a long period of time, it is **dramatic**.

We recall that there are 86,400 seconds in a day. For simplicity, we define a “day” to be  $10^5 \text{ s}$  ( $\sim 28$  hours).



A pressure tendency of  $1 \text{ Pa s}^{-1}$  may not sound impressive but, if sustained over a long period of time, it is **dramatic**.

We recall that there are 86,400 seconds in a day. For simplicity, we define a “day” to be  $10^5 \text{ s}$  ( $\sim 28$  hours).

The pressure change in a “day” will then be the tendency ( $dp/dt$ ) multiplied by the number of seconds in a “day”:

$$\Delta p = (1 \text{ Pa s}^{-1}) \times (10^5 \text{ s}) = 10^5 \text{ Pa}$$

Thus, the pressure will increase by  $10^5$  Pascals in a day.

A pressure tendency of  $1 \text{ Pa s}^{-1}$  may not sound impressive but, if sustained over a long period of time, it is **dramatic**.

We recall that there are 86,400 seconds in a day. For simplicity, we define a “day” to be  $10^5 \text{ s}$  ( $\sim 28$  hours).

The pressure change in a “day” will then be the tendency ( $dp/dt$ ) multiplied by the number of seconds in a “day”:

$$\Delta p = (1 \text{ Pa s}^{-1}) \times (10^5 \text{ s}) = 10^5 \text{ Pa}$$

Thus, the pressure will increase by  $10^5$  Pascals in a day.

But this is the same as its initial value, so:

**The pressure increases by 100% in a day!**

A pressure tendency of  $1 \text{ Pa s}^{-1}$  may not sound impressive but, if sustained over a long period of time, it is **dramatic**.

We recall that there are 86,400 seconds in a day. For simplicity, we define a “day” to be  $10^5 \text{ s}$  ( $\sim 28$  hours).

The pressure change in a “day” will then be the tendency ( $dp/dt$ ) multiplied by the number of seconds in a “day”:

$$\Delta p = (1 \text{ Pa s}^{-1}) \times (10^5 \text{ s}) = 10^5 \text{ Pa}$$

Thus, the pressure will increase by  $10^5$  Pascals in a day.

But this is the same as its initial value, so:

**The pressure increases by 100% in a day!**

And this is due to a difference in wind speed so small that *we cannot even measure it* ( $\Delta u = 0.1 \text{ m s}^{-1}$ ).

An even more paradoxical conclusion is reached if we consider the speed at the western face to be **1% less than** the outflow speed at the eastern face.

The above reasoning would suggest a **decrease of pressure by 100% in a day**, resulting in a **total vacuum** and *leaving the citizens of London quite breathless.*

★ ★ ★

An even more paradoxical conclusion is reached if we consider the speed at the western face to be **1% less than** the outflow speed at the eastern face.

The above reasoning would suggest a **decrease of pressure by 100% in a day**, resulting in a **total vacuum** and *leaving the citizens of London quite breathless.*

★ ★ ★

Of course, there is a **blunder** in the reasoning: as the mass in the ‘cube’ decreases, its volume must decrease in proportion, since the density is constant.

The fluid depth, which we took to be constant, must decrease.

★ ★ ★

An even more paradoxical conclusion is reached if we consider the speed at the western face to be *1% less than* the outflow speed at the eastern face.

The above reasoning would suggest a **decrease of pressure by 100% in a day**, resulting in a total vacuum and *leaving the citizens of London quite breathless*.

★ ★ ★

Of course, there is a **blunder** in the reasoning: as the mass in the ‘cube’ decreases, its volume must decrease in proportion, since the density is constant.

The fluid depth, which we took to be constant, must decrease.

★ ★ ★

Margules concluded that any attempt to forecast the weather was *“immoral and damaging to the character of a meteorologist”* (Fortak, 2001).

The Second Reading from

**The Book of Limerick**

# The Second Reading from The Book of Limerick

Said Margules, with **trepidation**,  
“There’s hazards with mass **conservation**:



# The Second Reading from The Book of Limerick

Said Margules, with trepidation,  
“There’s hazards with mass conservation:  
Gross errors you’ll see  
In *dee-pee-dee-tee*,

# The Second Reading from The Book of Limerick

Said Margules, with trepidation,  
“There’s hazards with mass conservation:  
Gross errors you’ll see  
In *dee-pee-dee-tee*,  
Arising from blind computation”.

# Gravity Waves

While the calculated pressure tendency is arithmetically correct, the resulting pressure change over a day is meteorologically preposterous. **Why?**



# Gravity Waves

While the calculated pressure tendency is arithmetically correct, the resulting pressure change over a day is meteorologically preposterous. **Why?**

★ ★ ★

We have extrapolated the *instantaneous* pressure change, assuming it to remain *constant* over a long time period.

An increase of pressure within the cube causes an immediate *outward pressure gradient* which opposes further change.

Indeed, the result of this negative feedback is for over-compensation, and a **cycle of pressure oscillations** ensues.

These oscillations are known as **gravity waves**, and they radiate outwards with high speed from a localised disturbance, dispersing it over a wider area.

As soon as an imbalance arises in the atmosphere, these gravity waves act in such a way as to restore balance.

These oscillations are known as **gravity waves**, and they radiate outwards with high speed from a localised disturbance, dispersing it over a wider area.

As soon as an imbalance arises in the atmosphere, these gravity waves act in such a way as to restore balance.

Since they are of high frequency, they result in pressure changes which are large but which oscillate rapidly in time:

*The instantaneous rate of change is not a reliable indicator of the long-term change.*

These oscillations are known as **gravity waves**, and they radiate outwards with high speed from a localised disturbance, dispersing it over a wider area.

As soon as an imbalance arises in the atmosphere, these gravity waves act in such a way as to **restore balance**.

Since they are of high frequency, they result in pressure changes which are large but which oscillate rapidly in time:

*The instantaneous rate of change is not a reliable indicator of the long-term change.*

The computational **time step** has to be short enough to allow the adjustment process to take place.

Then, gravity-wave oscillations may be present, but they need not spoil the forecast.

Gravity-wave oscillations may be effectively removed by a *minor adjustment of the initial data*; this process is called **initialization**.

Modern numerical forecasts are made using the continuity equation, but initialization controls excessive gravity wave noise and a small time step ensures that the calculations remain stable.





Gravity-wave oscillations may be effectively removed by a *minor adjustment of the initial data*; this process is called **initialization**.

Modern numerical forecasts are made using the continuity equation, but initialization controls excessive gravity wave noise and a small time step ensures that the calculations remain stable.

★ ★ ★

Bjerknes ruled out analytical solution of the mathematical equations, due to their nonlinearity and complexity.

However, there was a scientist more bold — or foolhardy — than Bjerknes, who actually tried to calculate future weather. This was **Lewis Fry Richardson**

# Richardson's Forecast

During the First World War, Lewis Fry Richardson carried out a manual calculation of the change in pressure over Central Europe (Richardson, 1922).

His initial data were based on a series of synoptic charts published in Leipzig by Vilhelm Bjerknes.

Using Bjerknes' charts, he extracted the relevant values on a discrete grid, and computed the rate of change of pressure for a region in Southern Germany.

# Richardson's Forecast

During the First World War, Lewis Fry Richardson carried out a manual calculation of the change in pressure over Central Europe (Richardson, 1922).

His initial data were based on a series of synoptic charts published in Leipzig by Vilhelm Bjerknes.

Using Bjerknes' charts, he extracted the relevant values on a discrete grid, and computed the rate of change of pressure for a region in Southern Germany.

To do this, **he used the continuity equation**, employing precisely the method which Margules had shown more than ten years earlier to be seriously problematical.

As is well known, the resulting “prediction” of pressure change was **completely unrealistic**.

# Lewis Fry Richardson, 1881–1953.





- Born, 11 October, 1881, Newcastle-upon-Tyne
- Family background: well-known quaker family
- 1900–1904: Kings College, Cambridge
- 1913–1916: Met. Office. Superintendent, Eskdalemuir Observatory
- Resigned from Met Office in May, 1916. Joined Friends' Ambulance Unit.
- 1919: Re-employed by Met. Office
- 1920: M.O. linked to the Air Ministry. LFR Resigned, on grounds of conscience
- **1922: Weather Prediction by Numerical Process**
- 1926: Break with Meteorology. Worked on Psychometric Studies. Later on Mathematical causes of Warfare
- 1940: Resigned to pursue “peace studies”
- Died, September, 1953.

Richardson contributed to **Meteorology, Numerical Analysis, Fractals, Psychology and Conflict Resolution.**

# The Finite Difference Scheme

The globe is divided into cells, like the checkers of a chess-board.

Spatial derivatives are replaced by finite differences:

$$\frac{df}{dx} \rightarrow \frac{f(x + \Delta x) - f(x - \Delta x)}{2\Delta x}.$$

Similarly for time derivatives:

$$\frac{dQ}{dt} \rightarrow \frac{Q^{n+1} - Q^{n-1}}{2\Delta t} = F^n$$

This can immediately be solved for  $Q^{n+1}$ :

$$Q^{n+1} = Q^{n-1} + 2\Delta t F^n.$$

By repeating the calculations for many time steps, we can get a forecast of any length.

Richardson calculated **only the initial rates of change.**

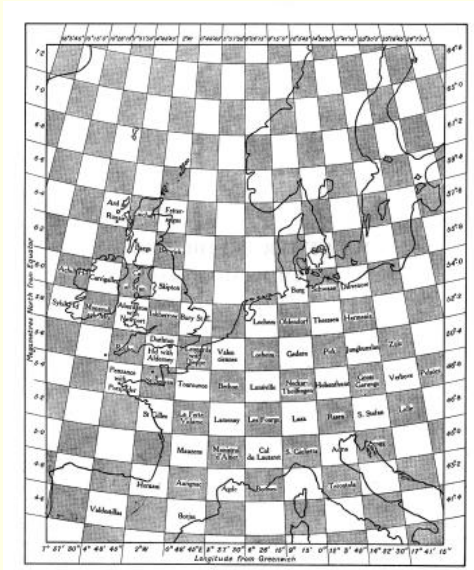



# The Leipzig Charts for 0700 UTC, May 20, 1910

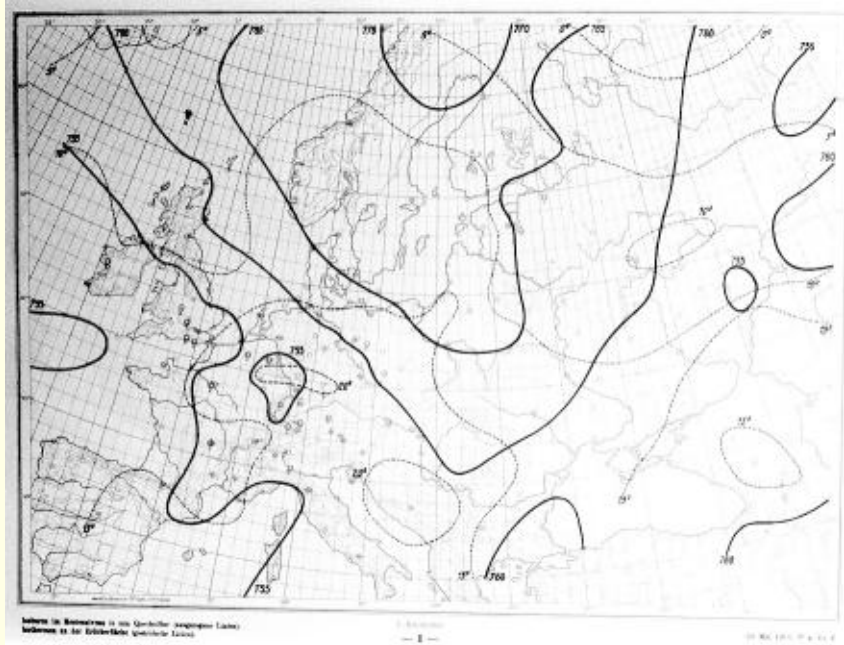

**Bjerknes' sea level pressure analysis.**

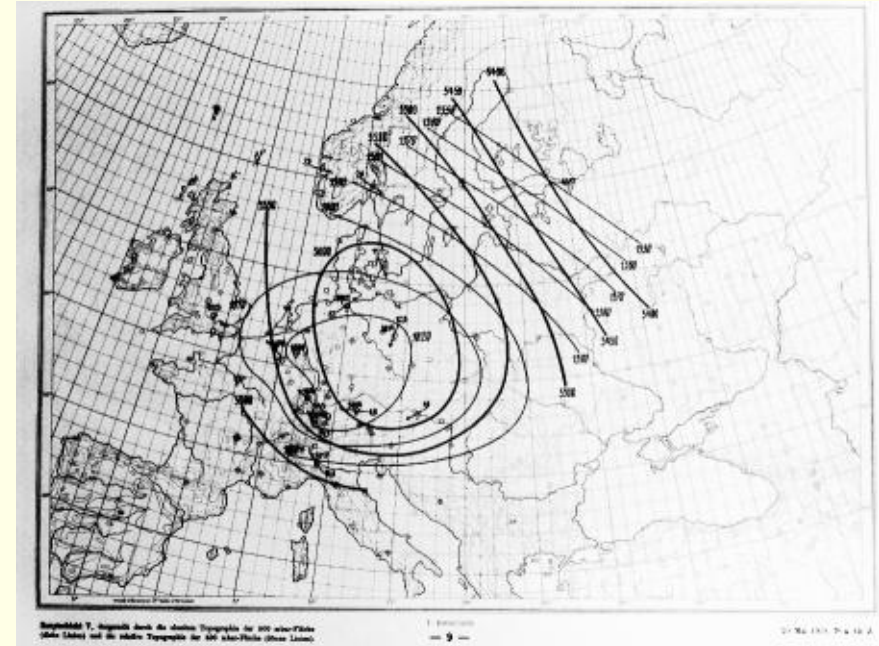

**Bjerknes' 500 hPa height analysis.**

Some of the initial data for Richardson's "forecast".

# Richardson's *Spread-sheet*

COMPUTING FORM P XIII. Divergence of horizontal momentum-per-area. Increase of pressure

The equation is typified by:  $-\frac{\partial R_{ps}}{\partial t} = \frac{\partial M_{Eps}}{\partial e} + \frac{\partial M_{Nps}}{\partial n} - M_{Nps} \frac{\tan \phi}{a} + m_{Hs} - m_{Hs}^* + \frac{2}{a} M_{Hps}$ . (See Ch. 4/2#5.)

\* In the equation for the lowest stratum the corresponding term  $-m_{gs}$  does not appear

Longitude $11^\circ$ East $\delta e = 441 \times 10^5$			Latitude $5400$ km North $\delta n = 400 \times 10^5$			Instant 1910 May 20 <sup>d</sup> 7 <sup>h</sup> G.M.T. $a^{-1} \cdot \tan \phi = 1.78 \times 10^{-9}$		Interval, $\delta t$ 6 hours $a = 6.36 \times 10^8$				
REF.:-			previous 3 columns	previous column		Form P xvi	Form P xvi	equation above	previous column	previous column	previous column	
$h$	$\frac{\delta M_E}{\delta e}$	$\frac{\delta M_N}{\delta n}$	$-\frac{M_N \tan \phi}{a}$	$\text{div}'_{EN} M$	$-g \delta t \text{div}'_{EN} M$	$m_H$	$\frac{2M_H}{a}$	$-\frac{\partial R}{\partial t}$	$+\frac{\partial R}{\partial t} \delta t$	$g \frac{\partial R}{\partial t} \delta t$	$\frac{\partial p}{\partial t} \delta t$	
	$10^{-5} \times$	$10^{-5} \times$	$10^{-5} \times$	$10^{-5} \times$	$100 \times$	$10^{-5} \times$	$10^{-5} \times$	$10^{-5} \times$		$100 \times$	$100 \times$	
$h_0$	-61	-245	-6	-312	656	0		-229	49.5	483	0	
$h_2$	367	-257	2	112	-236	-83		-136	29.4	287	483	
$h_4$	93	-303	-16	-226	478	165		-124	26.8	262	770	
$h_6$	32	-55	-12	-35	74	63		-110	23.8	233	1032	
$h_8$	-256	38	-8	-226	479	138		-88	19.0	186	1265	
$h_{10}$											1451	
	NOTE: $\text{div}'_{EN} M$ is a contraction for $\frac{\delta M_E}{\delta e} + \frac{\delta M_N}{\delta n} - M_N \frac{\tan \phi}{a}$				SUM = 1451 $= \frac{\partial p_a}{\partial t} \delta t$	Leave the subsequent columns to be filled up after the vertical velocity has been computed on Form P xvi						check by $\Sigma -g \delta t \text{div}'_{EN} M$

## Richardson's Computing Form P<sub>XIII</sub>

The figure in the bottom right corner is the forecast change in surface pressure: **145 mb in six hours!**



# Richardson's *Spread-sheet*

COMPUTING FORM P XIII. Divergence of horizontal momentum-per-area. Increase of pressure

The equation is typified by:  $-\frac{\partial R_{gs}}{\partial t} = \frac{\partial M_{E88}}{\partial e} + \frac{\partial M_{N88}}{\partial n} - M_{N88} \frac{\tan \phi}{a} + m_{H8} - m_{H8}^* + \frac{2}{a} M_{H88}$ . (See Ch. 4/2#5.)

\* In the equation for the lowest stratum the corresponding term  $-m_{gs}$  does not appear

Longitude $11^\circ$ East $\delta e = 441 \times 10^5$			Latitude $5400$ km North $\delta n = 400 \times 10^5$			Instant 1910 May 20 <sup>d</sup> 7 <sup>h</sup> G.M.T. $a^{-1} \cdot \tan \phi = 1.78 \times 10^{-9}$			Interval, $\delta t$ 6 hours $a = 6.36 \times 10^8$			
Ref.:-			previous 3 columns	previous column		Form P xvi	Form P xvi	equation above	previous column	previous column	previous column	
$h$	$\frac{\delta M_E}{\delta e}$	$\frac{\delta M_N}{\delta n}$	$-\frac{M_N \tan \phi}{a}$	$\text{div}'_{EN} M$	$-g \delta t \text{div}'_{EN} M$	$m_H$	$\frac{2M_H}{a}$	$-\frac{\partial R}{\partial t}$	$+\frac{\partial R}{\partial t} \delta t$	$g \frac{\partial R}{\partial t} \delta t$	$\frac{\partial p}{\partial t} \delta t$	
	$10^{-5} \times$	$10^{-5} \times$	$10^{-5} \times$	$10^{-5} \times$	$100 \times$	$10^{-5} \times$	$10^{-5} \times$	$10^{-5} \times$		$100 \times$	$100 \times$	
$h_0$	-61	-245	-6	-312	656	0		-229	49.5	483	0	
$h_2$	367	-257	2	112	-236	-83		-136	29.4	287	483	
$h_4$	93	-303	-16	-226	478	165		-124	26.8	262	770	
$h_6$	32	-55	-12	-35	74	63		-110	23.8	233	1032	
$h_8$	-256	38	-8	-226	479	138		-88	19.0	186	1265	
$h_{10}$											1451	
	NOTE: $\text{div}'_{EN} M$ is a contraction for $\frac{\delta M_E}{\delta e} + \frac{\delta M_N}{\delta n} - M_N \frac{\tan \phi}{a}$				SUM = 1451 $= \frac{\partial p}{\partial t} \delta t$	Leave the subsequent columns to be filled up after the vertical velocity has been computed on Form P xvi						check by $\Sigma -g \delta t \text{div}'_{EN} M$

## Richardson's Computing Form P XIII

The figure in the bottom right corner is the forecast change in surface pressure: **145 mb in six hours!**

In SI units, the pressure change was **14500 Pa.**

# Smooth Evolution of Pressure

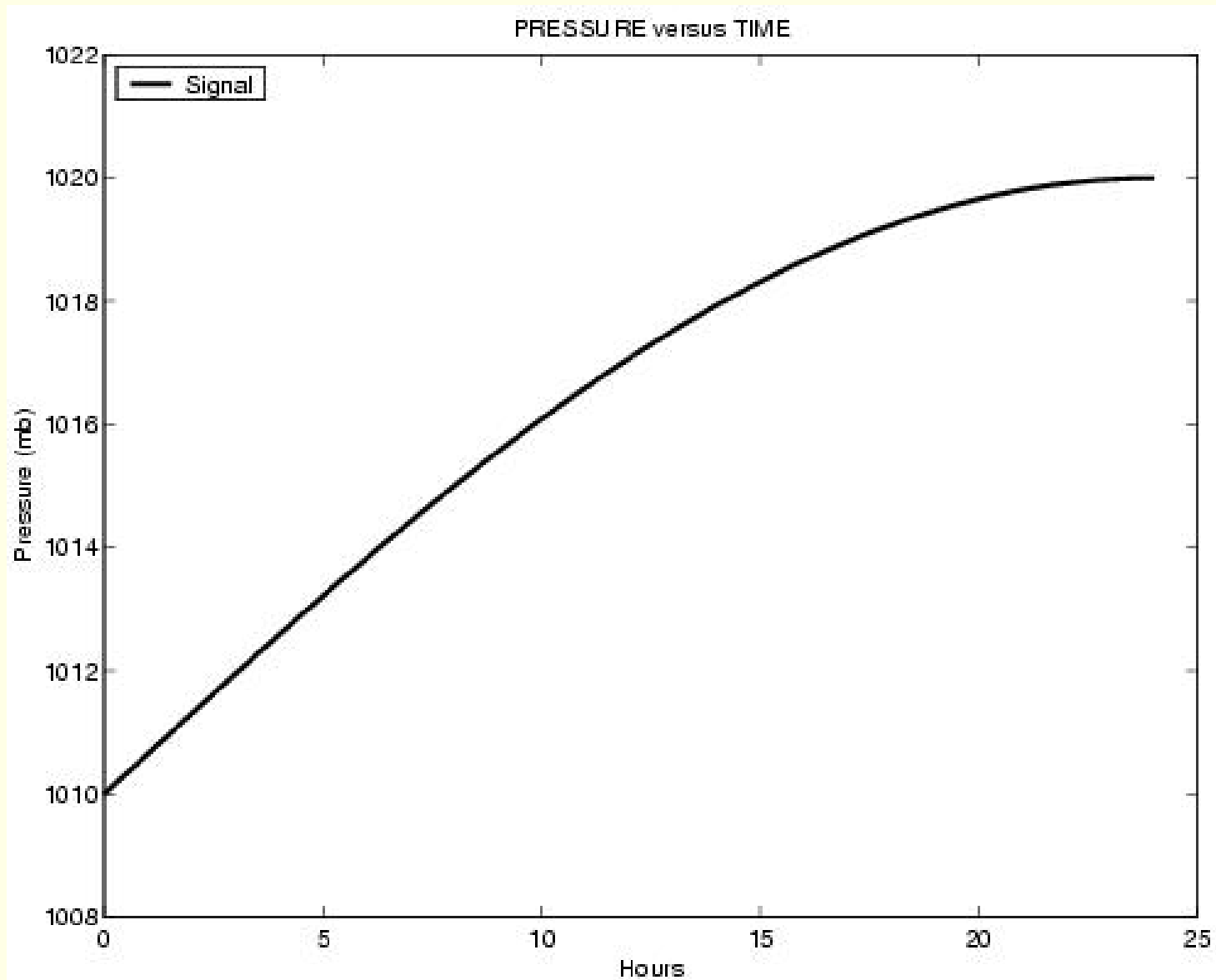

# Noisy Evolution of Pressure

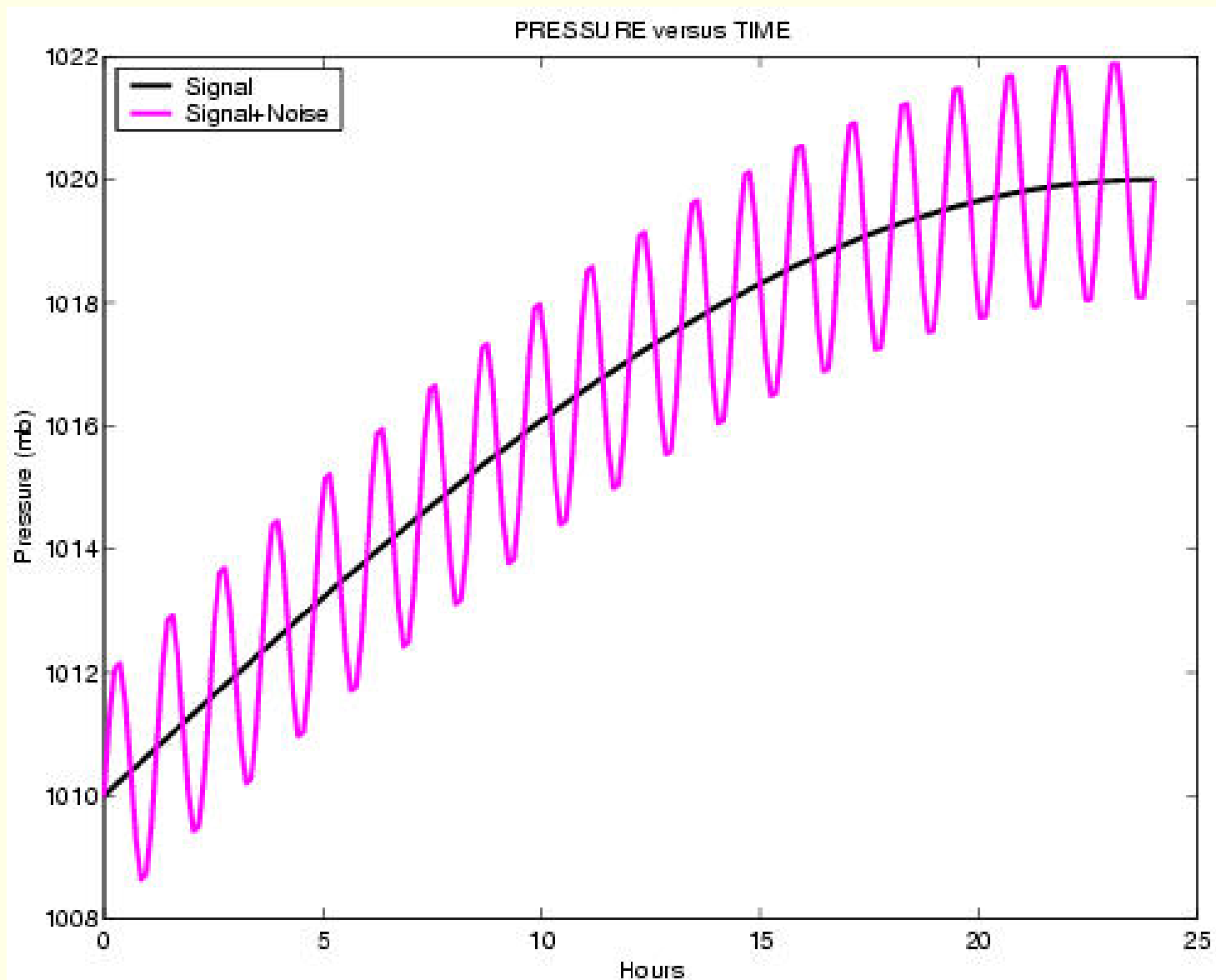

# Tendency of a Smooth Signal

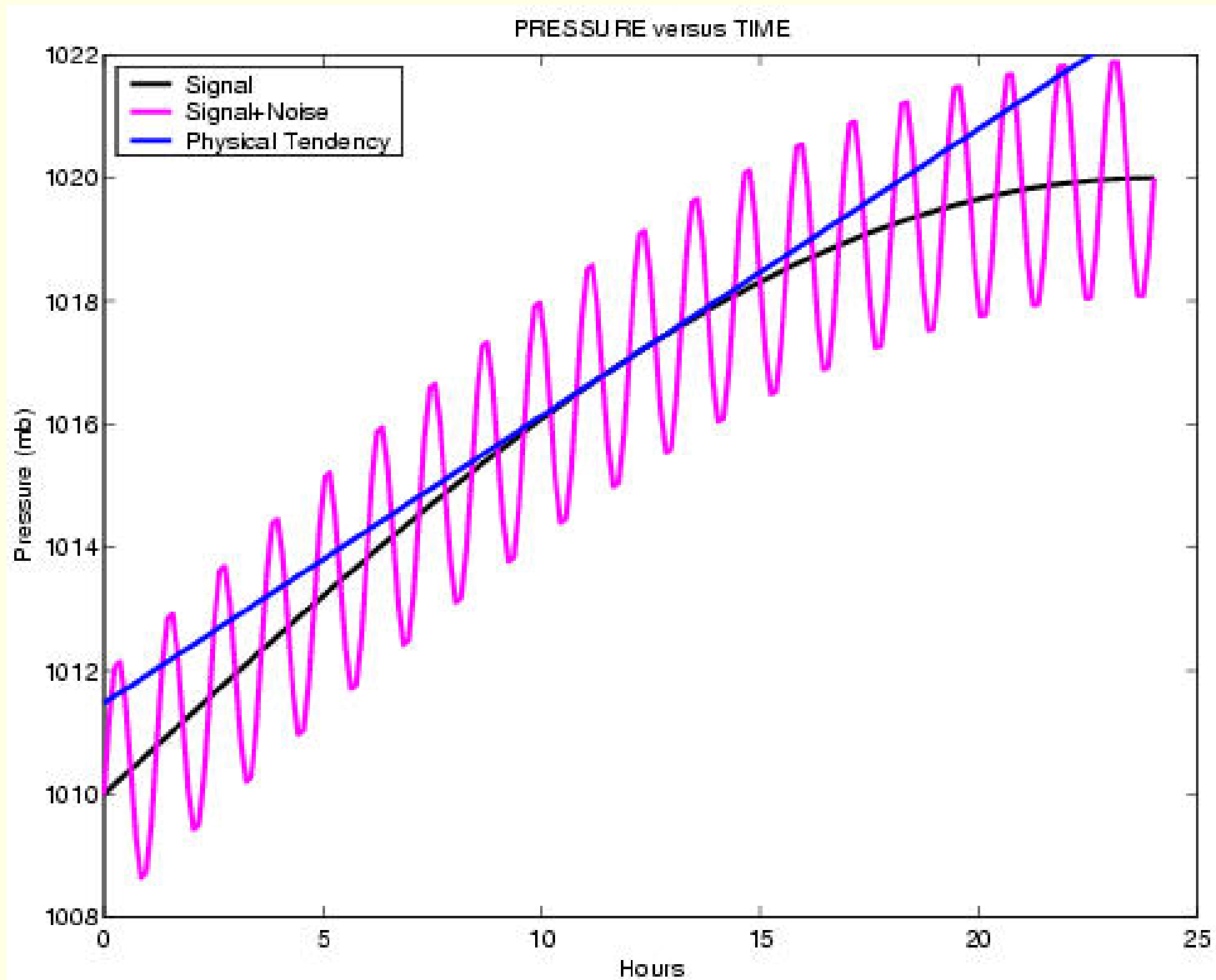

# Tendency of a Noisy Signal

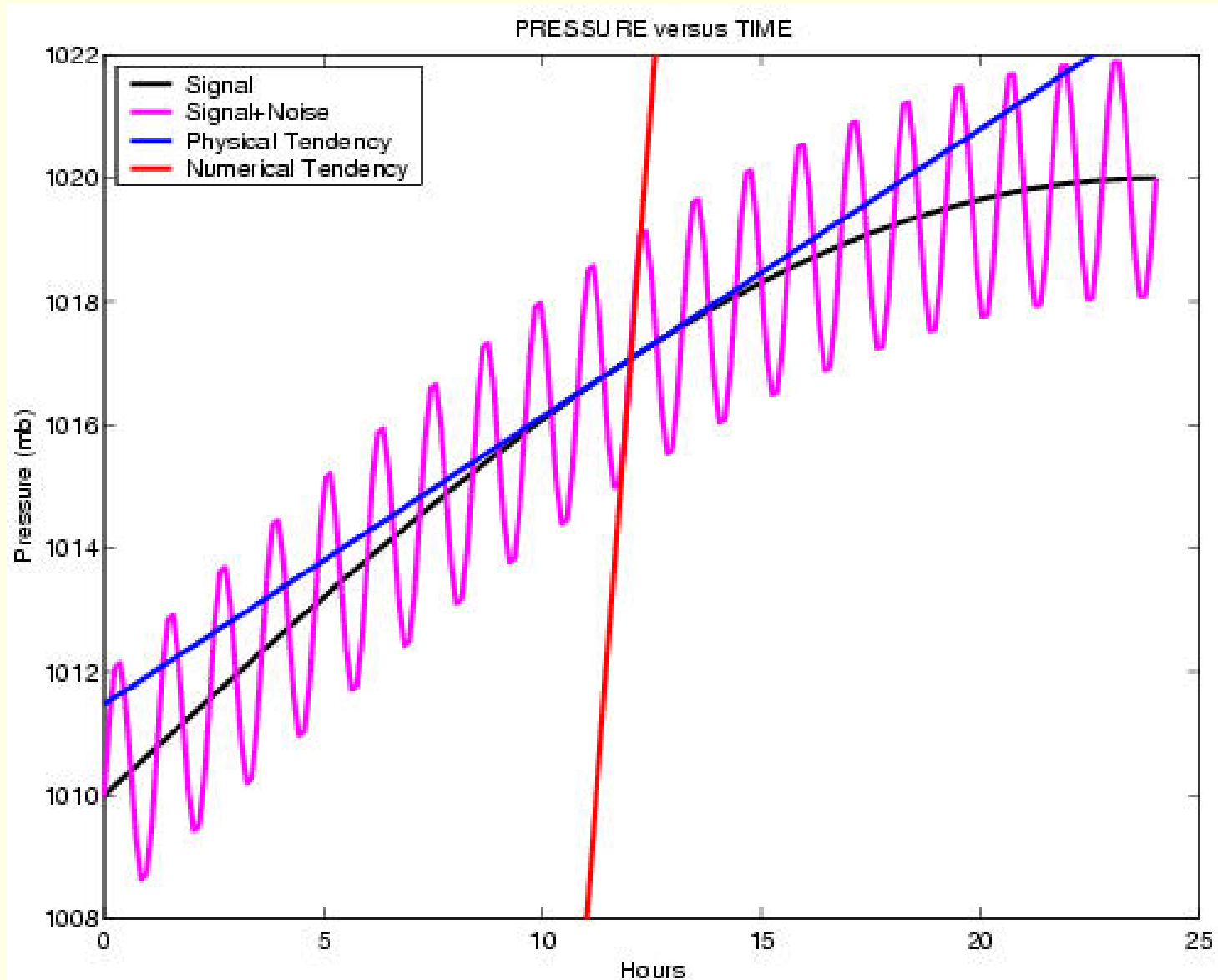

The Third Reading from

**The Book of Limerick**

The Third Reading from

The Book of Limerick

Young Richardson wanted to know  
How quickly the pressure would grow.

The Third Reading from

# The Book of Limerick

Young Richardson wanted to know  
How quickly the pressure would grow.  
But, what a surprise, 'cos  
The six-hourly rise was,



# The Third Reading from The Book of Limerick

Young Richardson wanted to know  
How quickly the pressure would grow.  
But, what a surprise, 'cos  
The six-hourly rise was,  
In Pascals, **One Four Five Oh Oh!**



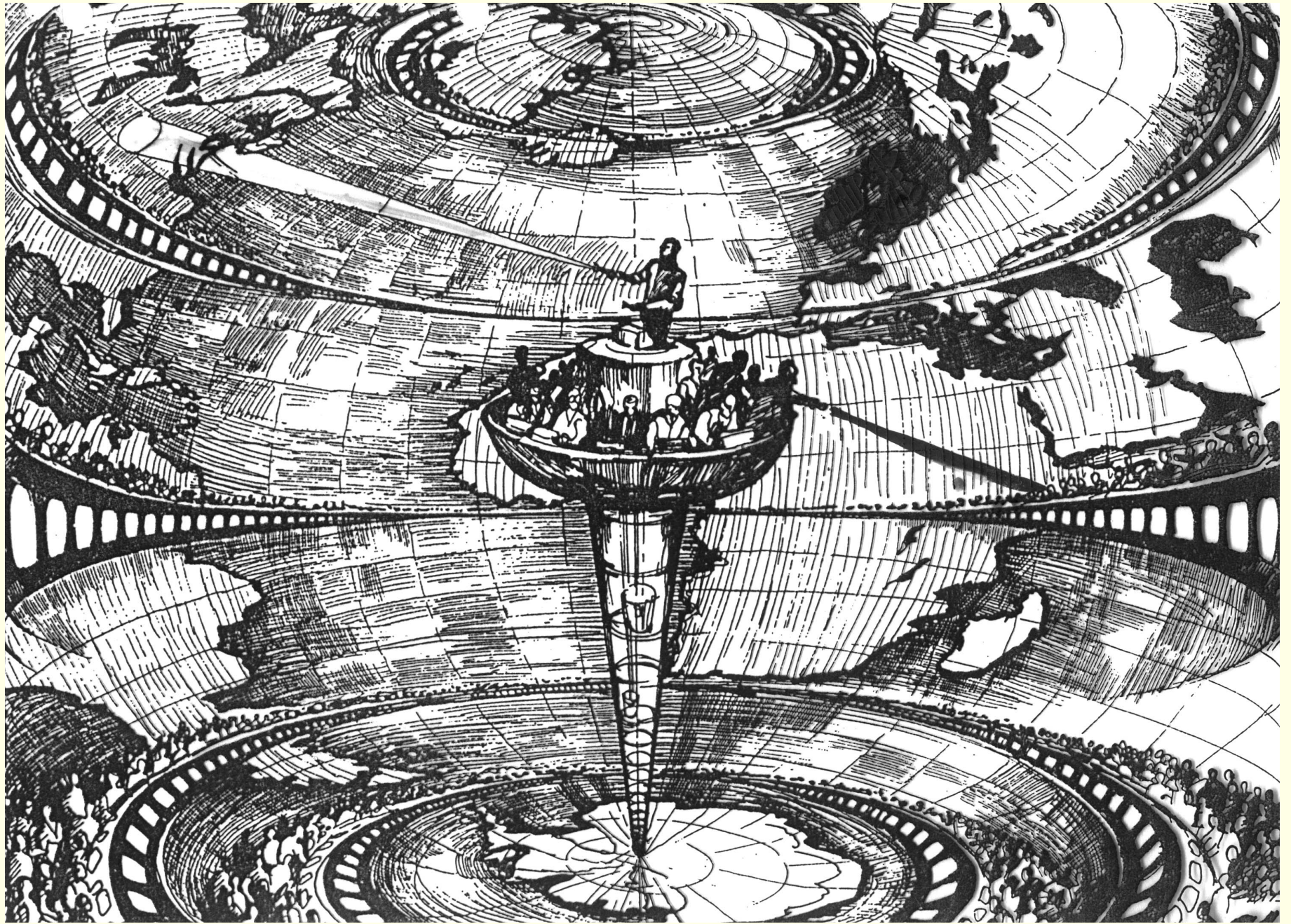

**Richardson's Forecast Factory (A. Lannerback).**  
Dagens Nyheter, Stockholm. Reproduced from L. Bengtsson, *ECMWF*, 1984



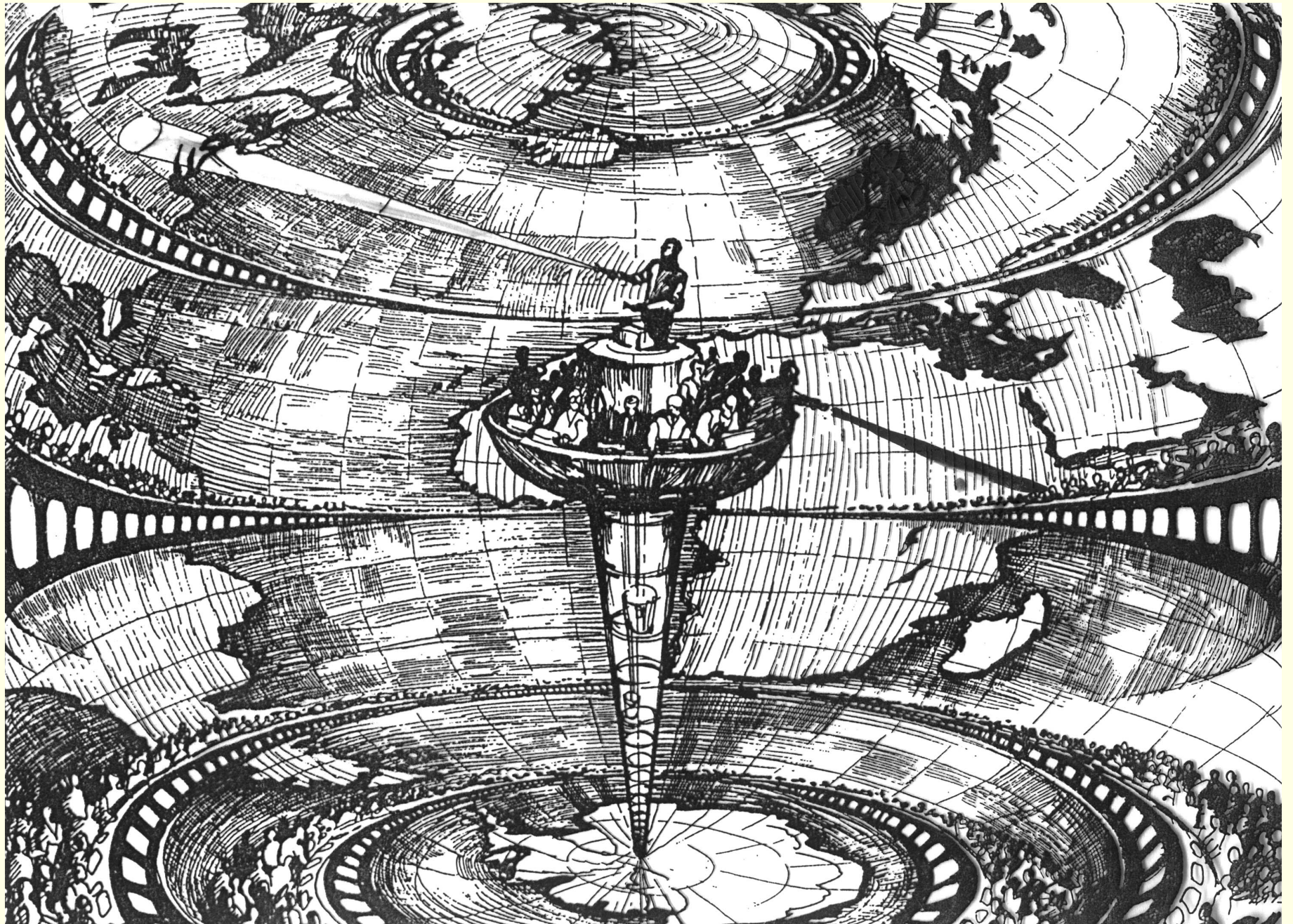

Richardson's Forecast Factory (A. Lannerback).  
Dagens Nyheter, Stockholm. Reproduced from L. Bengtsson, *ECMWF*, 1984

**64,000 Computers: The first Massively Parallel Processor**



# Advances 1920–1950

## ■ *Dynamic Meteorology*

- Rossby Waves
- Quasi-geostrophic Theory
- Baroclinic Instability

## ■ *Numerical Analysis*

- CFL Criterion

## ■ *Atmospheric Observations*

- Radiosonde

## ■ *Electronic Computing*

- ENIAC

# The ENIAC

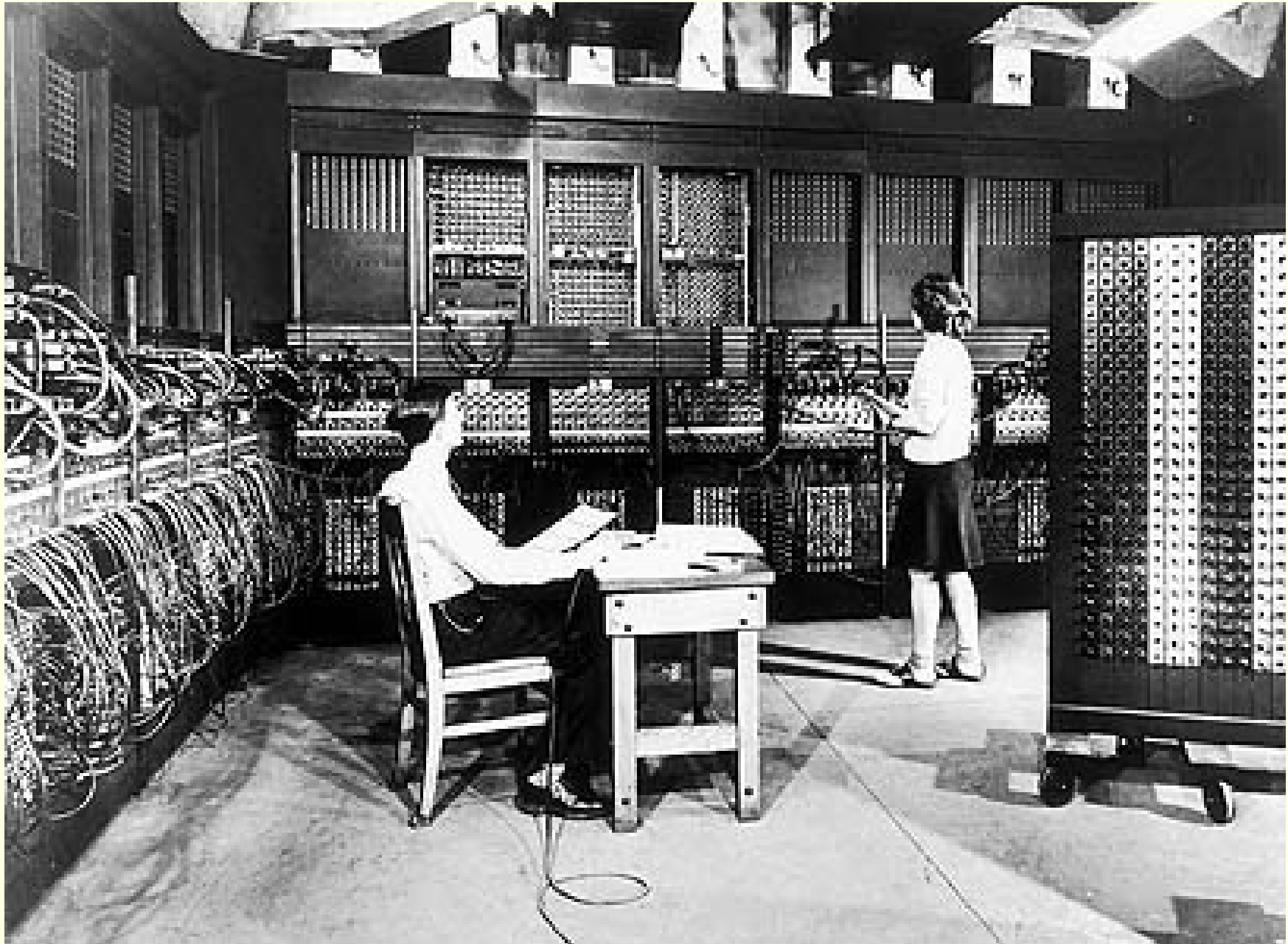

# Electronic Computer Project, 1946 (under direction of John von Neumann)

Von Neumann's idea:

Weather forecasting was a scientific problem *par excellence* for solution using a large computer.

The objective of the project was to study the problem of predicting the weather by simulating the dynamics of the atmosphere using a digital electronic computer.

A Proposal for funding listed three “possibilities”:

1. Entirely new methods of weather prediction by calculation will have been made possible;
2. A new rational basis will have been secured for the planning of physical measurements and field observations;
3. The first step towards influencing the weather by rational human intervention will have been made.

# The ENIAC

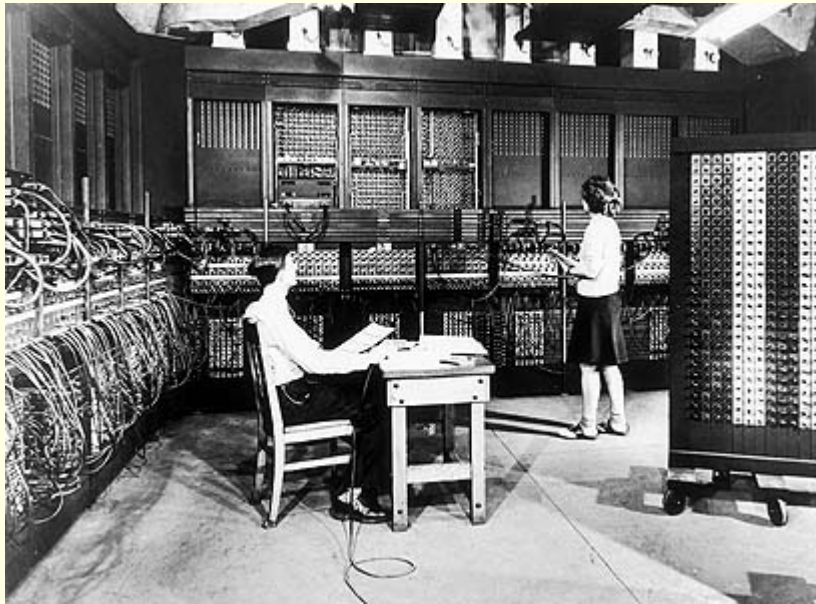

The **ENIAC** (Electronic Numerical Integrator and Computer) was the first multi-purpose programmable electronic digital computer.

It had:

- 18,000 vacuum tubes
- 70,000 resistors
- 10,000 capacitors
- 6,000 switches

Power Consumption: 140 kWatts

# The ENIAC: Technical Details.

ENIAC was a **decimal machine**. No high-level language.  
Assembly language. Fixed-point arithmetic:  $-1 < x < +1$ .  
10 registers, that is,

**Ten words of high-speed memory.**

Function Tables:

624 6-digit words of “ROM”, set on  
**ten-pole rotary switches.**

“Peripheral Memory”:

**Punch-cards.**

Speed: FP multiply: 2ms  
(say, **500 Flops**).

Access to Function Tables: **1ms.**

Access to Punch-card equipment:

**You can imagine!**

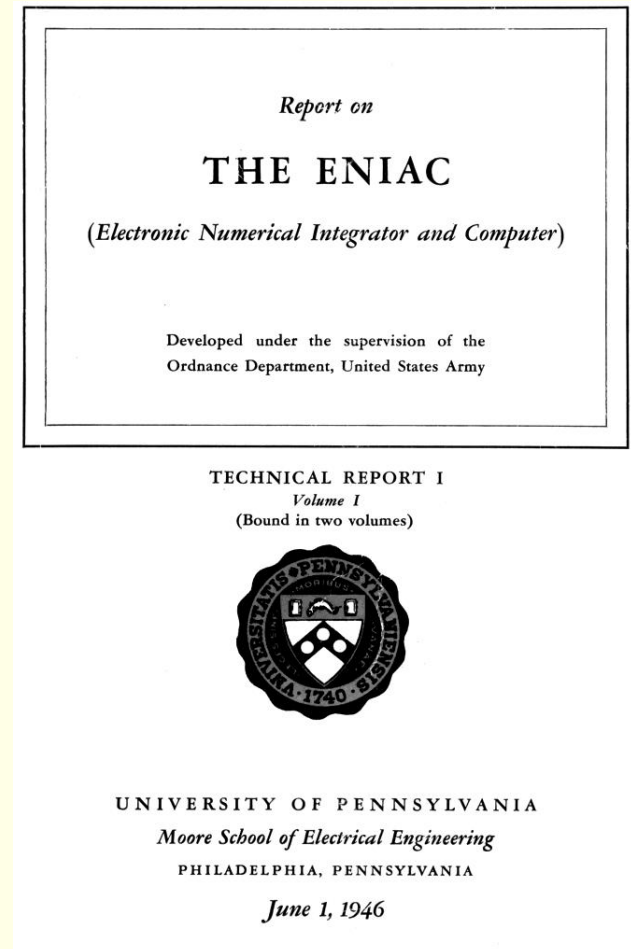



**Julius Charney** found the solution to the noise problem: he derived the the **Quasi-geostrophic** equations.

The *Q-geostrophic* equations are a *Filtered System*.

They have solutions corresponding to “weather waves” but no solutions corresponding to “noise waves”.

★ ★ ★

**Jule Charney** found the solution to the noise problem: he derived the the **Quasi-geostrophic** equations.

The *Q-geostrophic* equations are a *Filtered System*.

They have solutions corresponding to “weather waves” but no solutions corresponding to “noise waves”.

★ ★ ★

## *Evolution of the Project:*

- **Plan A: Integrate the Primitive Equations**  
*Problems similar to Richardson’s would arise*
- **Plan B: Integrate baroclinic Q-G System**  
*Too computationally demanding*
- **Plan C: Solve barotropic vorticity equation**  
*Very satisfactory initial results*

The Fourth Reading from

**The Book of Limerick**

# The Fourth Reading from The Book of Limerick

**Jule Charney** was quite philosophic:  
“The system called *Q-geostrophic*,

# The Fourth Reading from The Book of Limerick

**Jule Charney** was quite philosophic:  
“The system called *Q-geostrophic*,  
With filtered equations  
*Sans* fast oscillations,

# The Fourth Reading from The Book of Limerick

**Jule Charney** was quite philosophic:  
“The system called *Q-geostrophic*,  
With filtered equations  
*Sans* fast oscillations,  
Will obviate trends catastrophic”.

# Charney, Fjørtoft, von Neumann

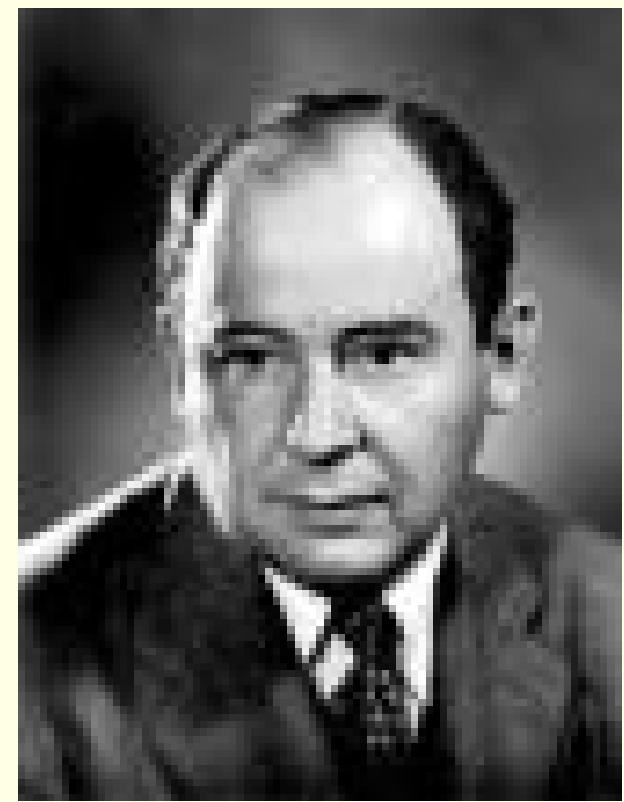
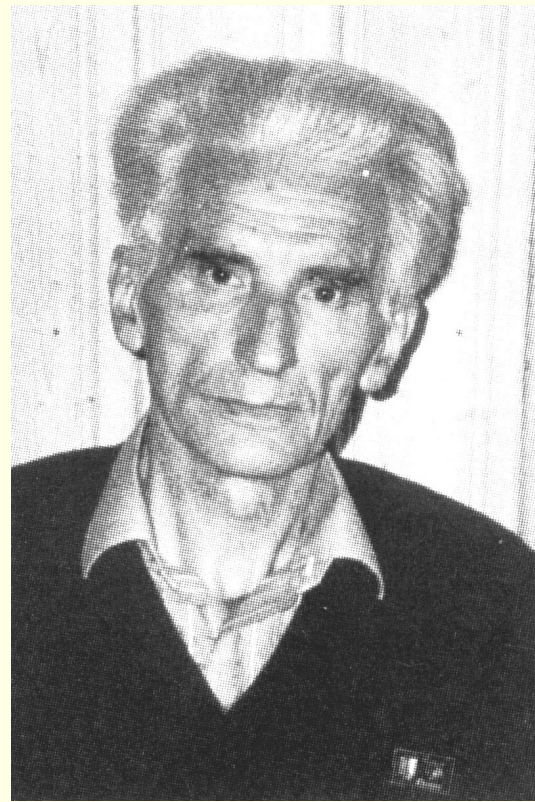

# Charney, et al., *Tellus*, 1950.

$$\left[ \begin{array}{c} \text{Absolute} \\ \text{Vorticity} \end{array} \right] = \left[ \begin{array}{c} \text{Relative} \\ \text{Vorticity} \end{array} \right] + \left[ \begin{array}{c} \text{Planetary} \\ \text{Vorticity} \end{array} \right] \quad \eta = \zeta + f.$$

The atmosphere is treated as a single layer, and the flow is assumed to be nondivergent. **Absolute vorticity is conserved** following the flow.

$$\frac{d(\zeta + f)}{dt} = 0.$$

This equation looks deceptively simple. But it is **nonlinear**:

$$\frac{\partial \zeta}{\partial t} + \mathbf{V} \cdot \nabla(\zeta + f) = 0.$$

Or, in more detail:

$$\frac{\partial}{\partial t} \nabla^2 \psi + \left\{ \frac{\partial \psi}{\partial x} \frac{\partial \nabla^2 \psi}{\partial y} - \frac{\partial \psi}{\partial y} \frac{\partial \nabla^2 \psi}{\partial x} \right\} + \beta \frac{\partial \psi}{\partial x} = 0,$$



# Solution method for BPVE

$$\frac{\partial \zeta}{\partial t} = -\mathbf{J}(\psi, \zeta + f)$$

1. Compute Jacobian
2. Step forward (Leapfrog scheme)
3. Solve Poisson equation for  $\psi$  (Fourier expansion)
4. Go to (1).
  - Timestep :  $\Delta t = 1$  hour (2 and 3 hours also tried)
  - Gridstep :  $\Delta x = 750$  km (approximately)
  - Gridsize :  $18 \times 15 = 270$  points
  - Elapsed time for 24 hour forecast: About 24 hours.

Forecast involved **punching about 25,000 cards**. Most of the elapsed time was spent handling these.

# ENIAC Algorithm

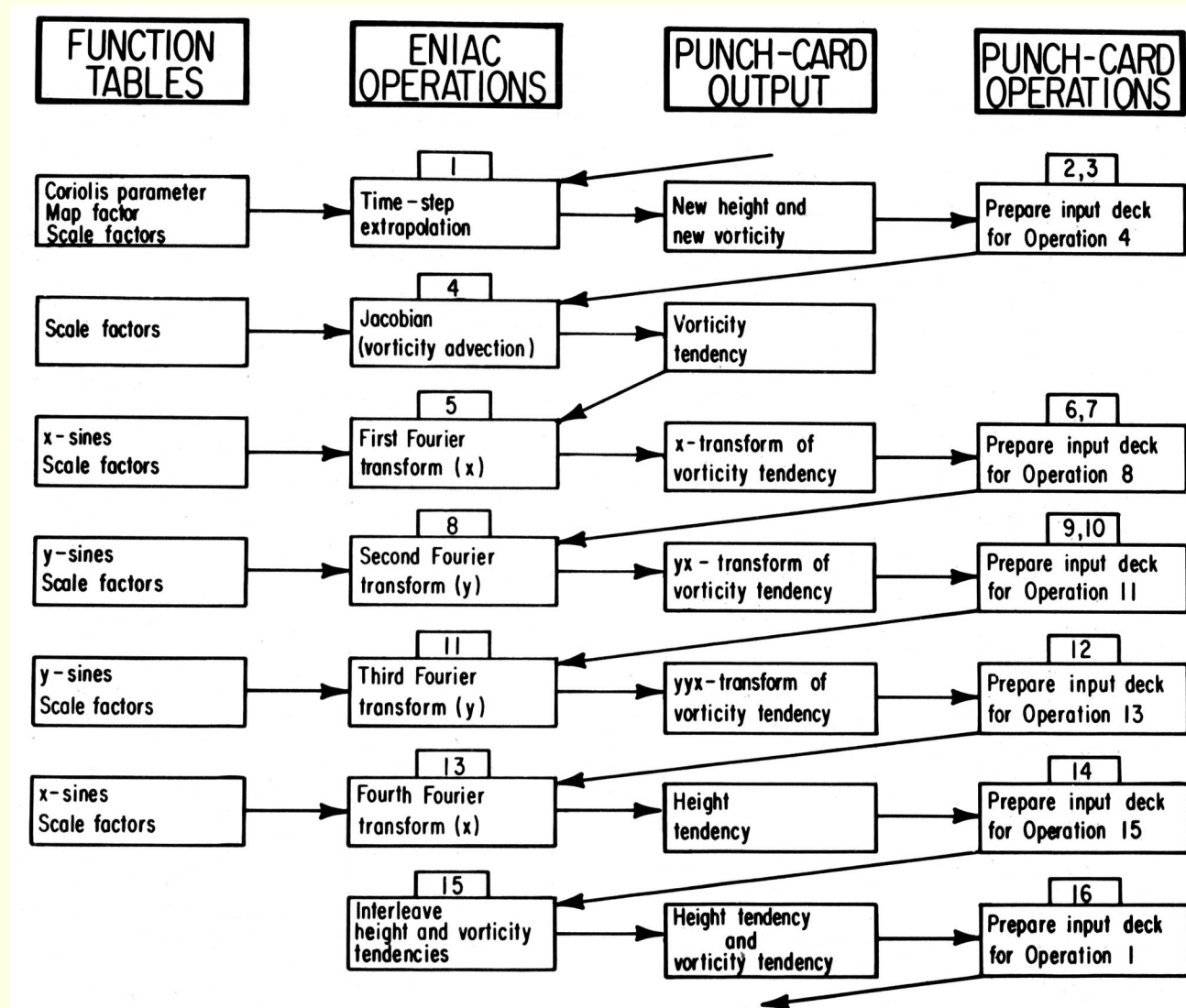

# ENIAC: First Computer Forecast

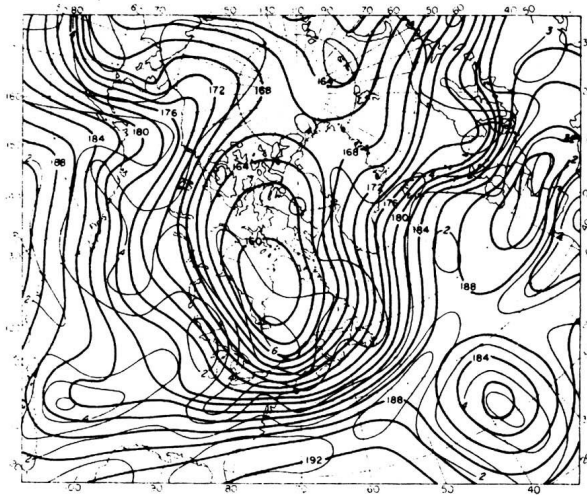

(A)

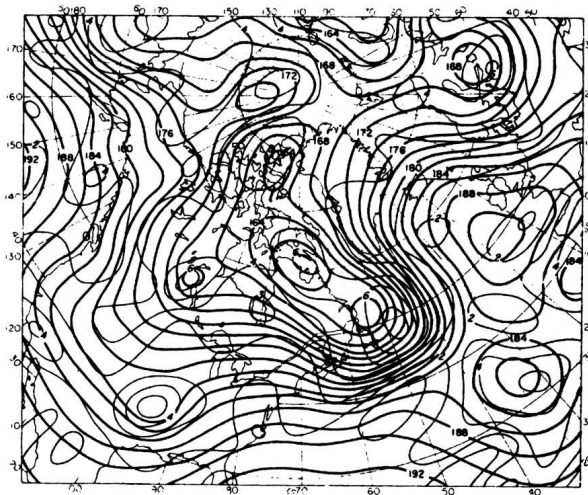

(B)

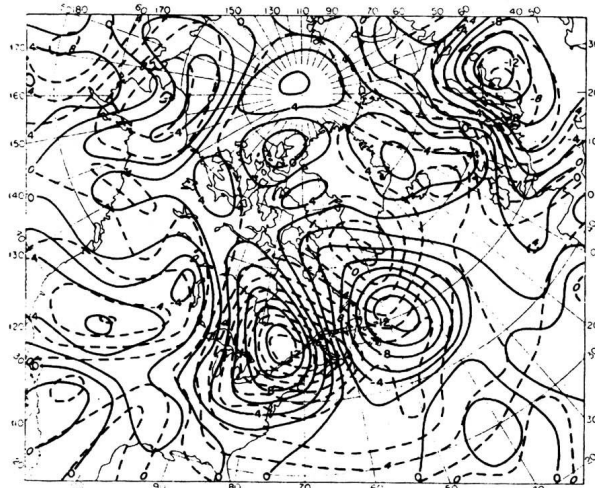

(C)

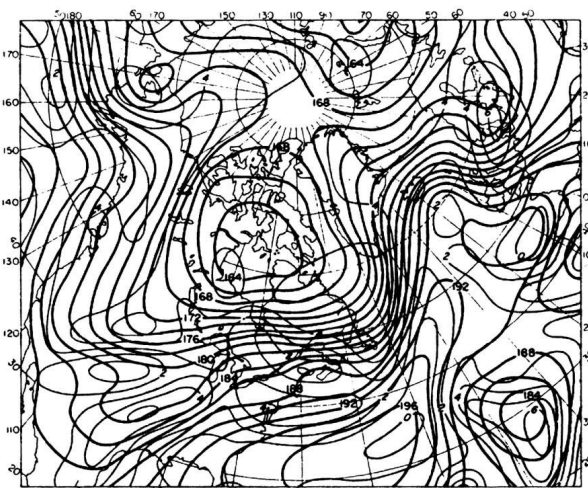

(D)

# Richardson's reaction

- *“Allow me to congratulate you and your collaborators on the remarkable progress which has been made in Princeton.*
- *“This is . . . **an enormous scientific advance** on the single, and quite wrong, result in which Richardson (1922) ended.*

The Fifth Reading from

**The Book of Limerick**

The Fifth Reading from

The Book of Limerick

Old Richardson's fabulous **notion**  
Of forecasting turbulent **motion**

The Fifth Reading from

# The Book of Limerick

Old Richardson's fabulous **notion**  
Of forecasting turbulent **motion**  
Seemed totally off-the-track,

# The Fifth Reading from

## The Book of Limerick

Old Richardson's fabulous notion  
Of forecasting turbulent motion  
Seemed totally off-the-track,  
But then came the ENIAC,  
To model the air and the ocean.



# NWP Operations

The Joint Numerical Weather Prediction (JNWP) Unit was established on July 1, 1954:

- *Air Weather Service of US Air Force*
- *The US Weather Bureau*
- *The Naval Weather Service.*

Operational numerical forecasting began on 15 May, 1955, using a three-level quasi-geostrophic model.

# Physical Laws of the Atmosphere

## GAS LAW (Boyle's Law and Charles' Law.)

Relates the pressure, temperature and density

## CONTINUITY EQUATION

Conservation of mass; air neither created nor destroyed

## WATER CONTINUITY EQUATION

Conservation of water (liquid, solid and gas)

## EQUATIONS OF MOTION: Navier-Stokes Equations

Describe how the change of velocity is determined by the pressure gradient, Coriolis force and friction

## THERMODYNAMIC EQUATION

Determines changes of temperature due to heating or cooling, compression or rarification, etc.

Seven equations; seven variables ( $u, v, w, \rho, p, T, q$ ).

# The Primitive Equations

$$\frac{du}{dt} - \left( f + \frac{u \tan \phi}{a} \right) v + \frac{1}{\rho} \frac{\partial p}{\partial x} + F_x = 0$$

$$\frac{dv}{dt} + \left( f + \frac{u \tan \phi}{a} \right) u + \frac{1}{\rho} \frac{\partial p}{\partial y} + F_y = 0$$

$$p = R\rho T$$

$$\frac{\partial p}{\partial y} + g\rho = 0$$

$$\frac{dT}{dt} + (\gamma - 1)T\nabla \cdot \mathbf{V} = \frac{Q}{c_p}$$

$$\frac{\partial \rho}{\partial t} + \nabla \cdot \rho \mathbf{V} = 0$$

$$\frac{\partial \rho_w}{\partial t} + \nabla \cdot \rho_w \mathbf{V} = [\text{Sources} - \text{Sinks}]$$

Seven equations; seven variables ( $u, v, w, p, T, \rho, \rho_w$ ).

# Scientific Weather Forecasting in a Nut-Shell

- The atmosphere is a **physical system**
  - Its behaviour is governed by the **laws of physics**
  - These laws are expressed quantitatively in the form of **mathematical equations**
  - Using **observations**, we can specify the atmospheric state at a given initial time: **“Today’s Weather”**
  - Using **the equations**, we can calculate how this state will change over time: **“Tomorrow’s Weather”**
-

# Scientific Weather Forecasting in a Nut-Shell

- The atmosphere is a **physical system**
  - Its behaviour is governed by the **laws of physics**
  - These laws are expressed quantitatively in the form of **mathematical equations**
  - Using **observations**, we can specify the atmospheric state at a given initial time: “**Today’s Weather**”
  - Using **the equations**, we can calculate how this state will change over time: “**Tomorrow’s Weather**”
- 
- The equations are very complicated (non-linear) and a **powerful computer** is required to do the calculations
  - The accuracy decreases as the range increases; there is an inherent **limit of predictability**.

Progress in numerical weather prediction over the past fifty years has been quite dramatic.

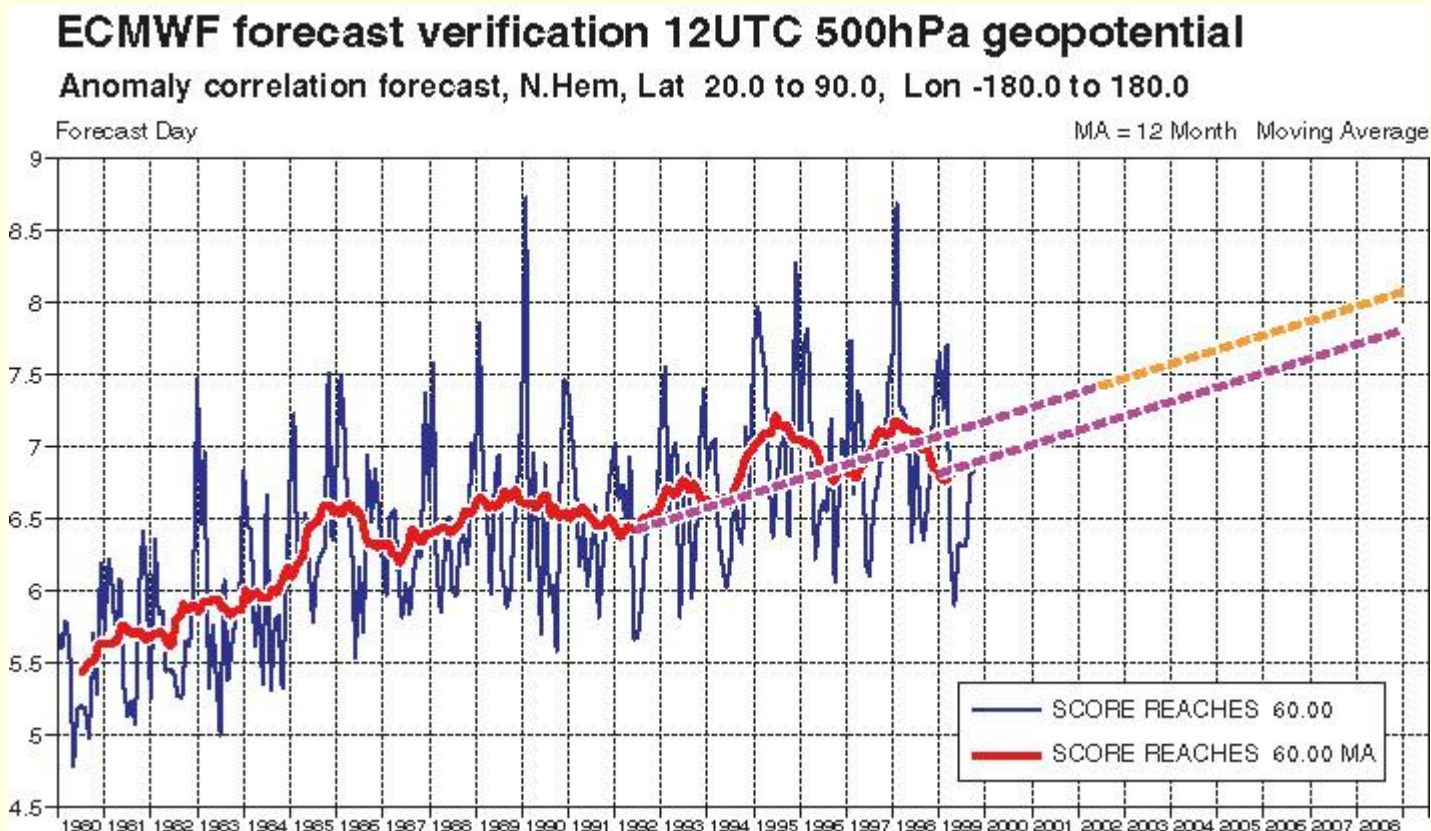

Forecast skill continues to increase.

Progress in numerical weather prediction over the past fifty years has been quite dramatic.

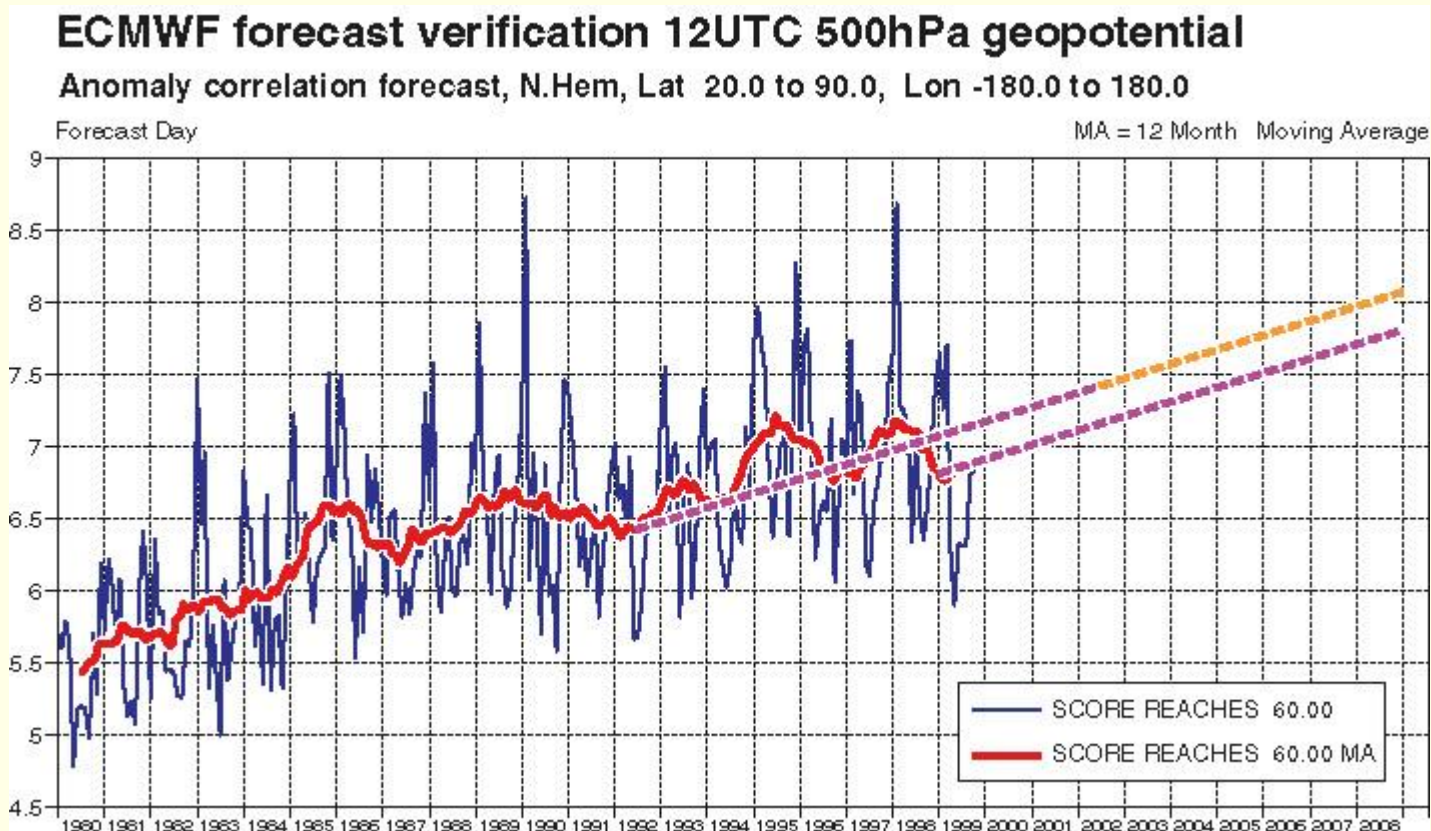

Forecast skill continues to increase.

However, **there is a limit . . .**



# Chaos in Atmospheric Flow

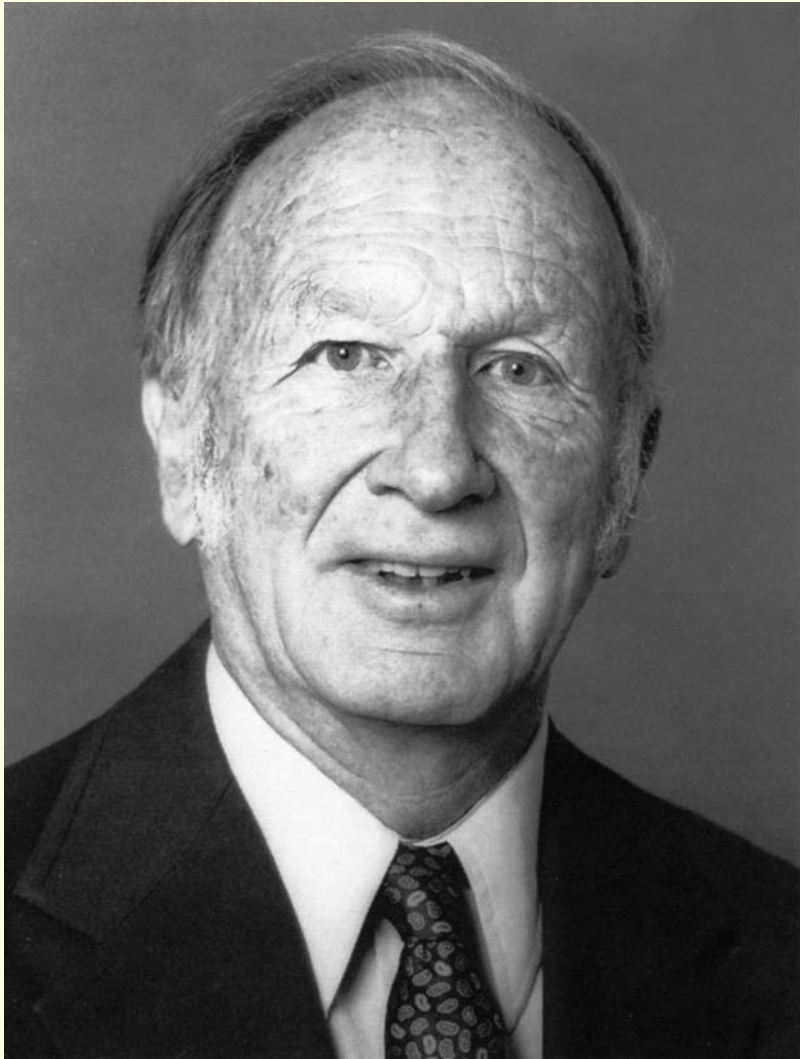

Edward Lorenz (b. 1917)

In a paper published in 1963, entitled *Deterministic Nonperiodic Flow*, Edward Lorenz showed that the simple system

$$\dot{x} = -\sigma x + \sigma y$$

$$\dot{y} = -xz + rx$$

$$\dot{z} = +xy - bz$$

has solutions which are highly *sensitive to the initial conditions*.



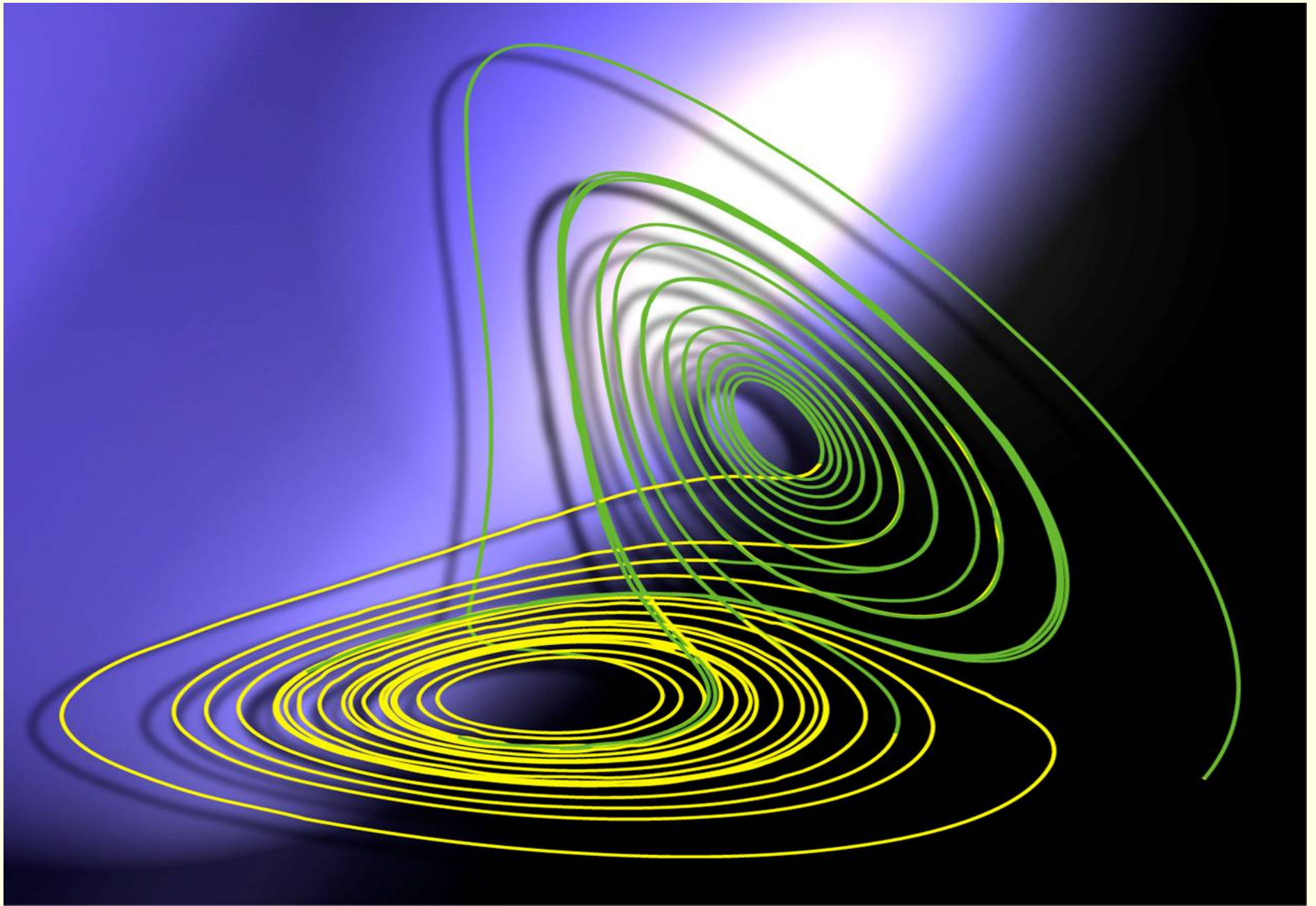

The characteristic *butterfly pattern* in Lorenz's Equations.

Lorenz's work demonstrated the practical impossibility of making accurate, detailed long-range weather forecasts.

This problem can be traced back to Poincaré, but it was Lorenz who formulated it in precise, quantitative terms.

Lorenz's work demonstrated the practical impossibility of making accurate, detailed long-range weather forecasts.

This problem can be traced back to Poincaré, but it was Lorenz who formulated it in precise, quantitative terms.

In his 1963 paper he wrote:

“... one flap of a sea-gull's wings may forever change the future course of the weather.”

Lorenz's work demonstrated the practical impossibility of making accurate, detailed long-range weather forecasts.

This problem can be traced back to Poincaré, but it was Lorenz who formulated it in precise, quantitative terms.

In his 1963 paper he wrote:

“... one flap of a sea-gull's wings may forever change the future course of the weather.”

Within a few years, he had changed species:

“Predictability:  
does the flap of a butterfly's wings in  
Brazil set off a tornado in Texas?”

[Title of a lecture at an AAAS conference in Washington.]

The Sixth Reading from

**The Book of Limerick**

# The Sixth Reading from The Book of Limerick

**Lorenz** demonstrated, with skill,  
The chaos of heat-wave and chill:

# The Sixth Reading from The Book of Limerick

**Lorenz** demonstrated, with skill,  
The chaos of heat-wave and chill:  
Tornadoes in **Texas**  
Are formed by the **flexes**  
Of butterflies' wings in **Brazil**.

# Flow-dependent Predictability

Weather forecasts lose skill because of the growth of errors in the initial conditions (**initial uncertainties**) and because numerical models describe the atmosphere only approximately (**model uncertainties**).



# Flow-dependent Predictability

Weather forecasts lose skill because of the growth of errors in the initial conditions (**initial uncertainties**) and because numerical models describe the atmosphere only approximately (**model uncertainties**).

As a further complication, predictability is **flow-dependent**.



The Lorenz model illustrates variations in predictability for different initial conditions.

# Variation in Predictability

---

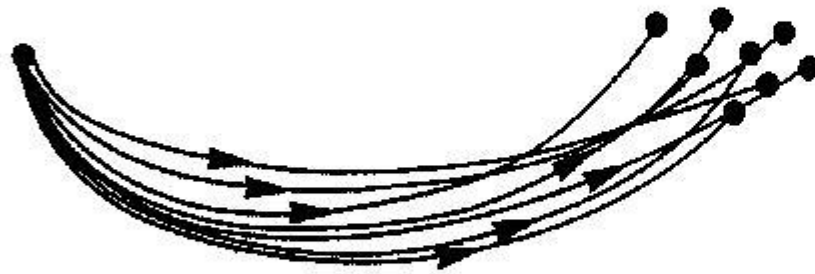

**Highly Predictable**

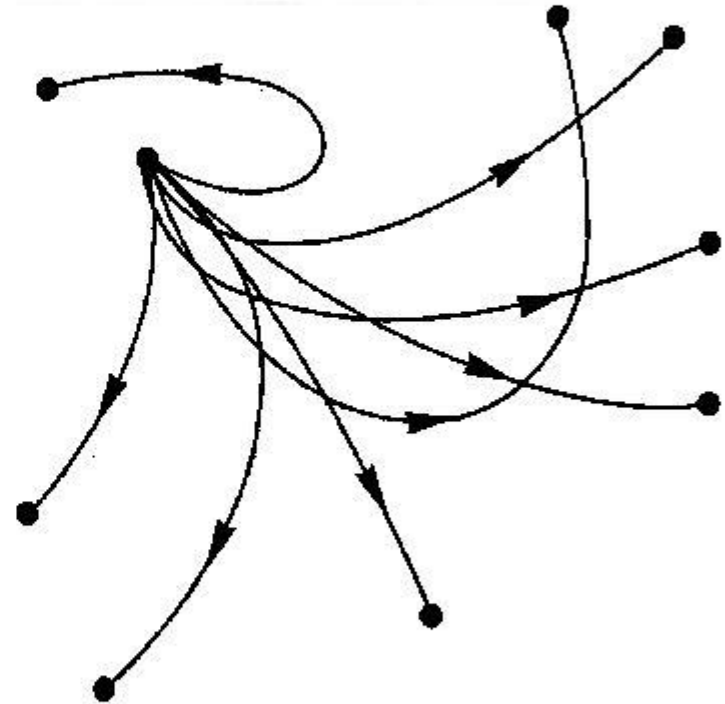

**Highly Unpredictable**



500z d:1997-02-09 12:00:00 fc+120h cl:od exp:1  
AN red/purple - CON blue/green - iso=5200-5700

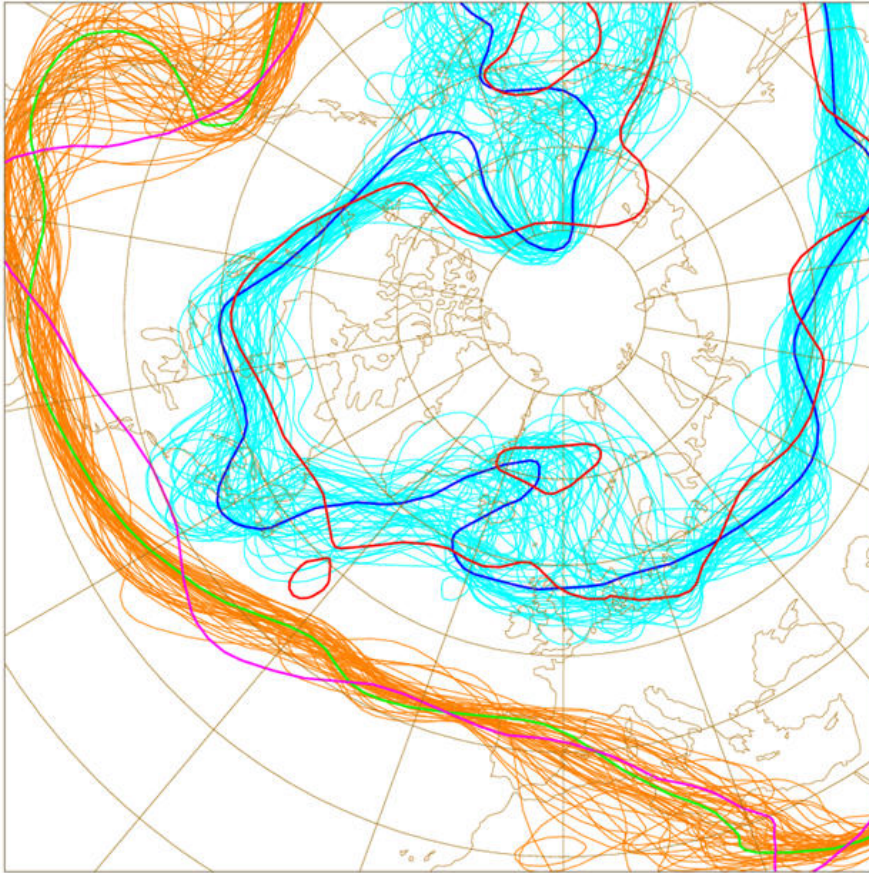

500z d:1997-03-13 12:00:00 fc+120h cl:od exp:1  
AN red/purple - CON blue/green - iso=5200-5700

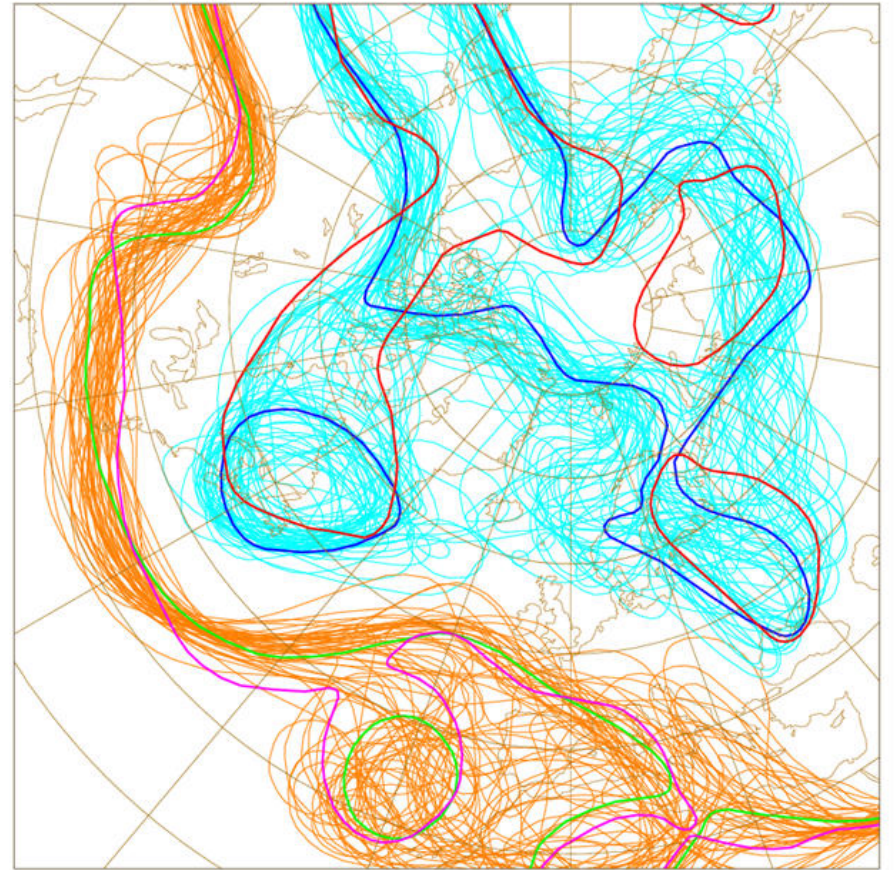

**Spaghetti plots** for ensembles from two starting times.

# Ensemble Forecasting

In recognition of the chaotic nature of the atmosphere, focus has now shifted to predicting the **probability of alternative weather events** rather than a single outcome.

# Ensemble Forecasting

In recognition of the chaotic nature of the atmosphere, focus has now shifted to predicting the **probability of alternative weather events** rather than a single outcome.



European Centre for Medium range Forecasts. Reading Headquarters.

The mechanism is the *Ensemble Prediction System* (EPS) and the world leader in this area is the **European Centre for Medium-range Weather Forecasts (ECMWF)**.



# A Sample Ensemble Forecast

The figure shows the verifying analysis (top left), and 15 132-hour (6.5 day) forecasts of sea-level pressure starting from slightly different conditions.

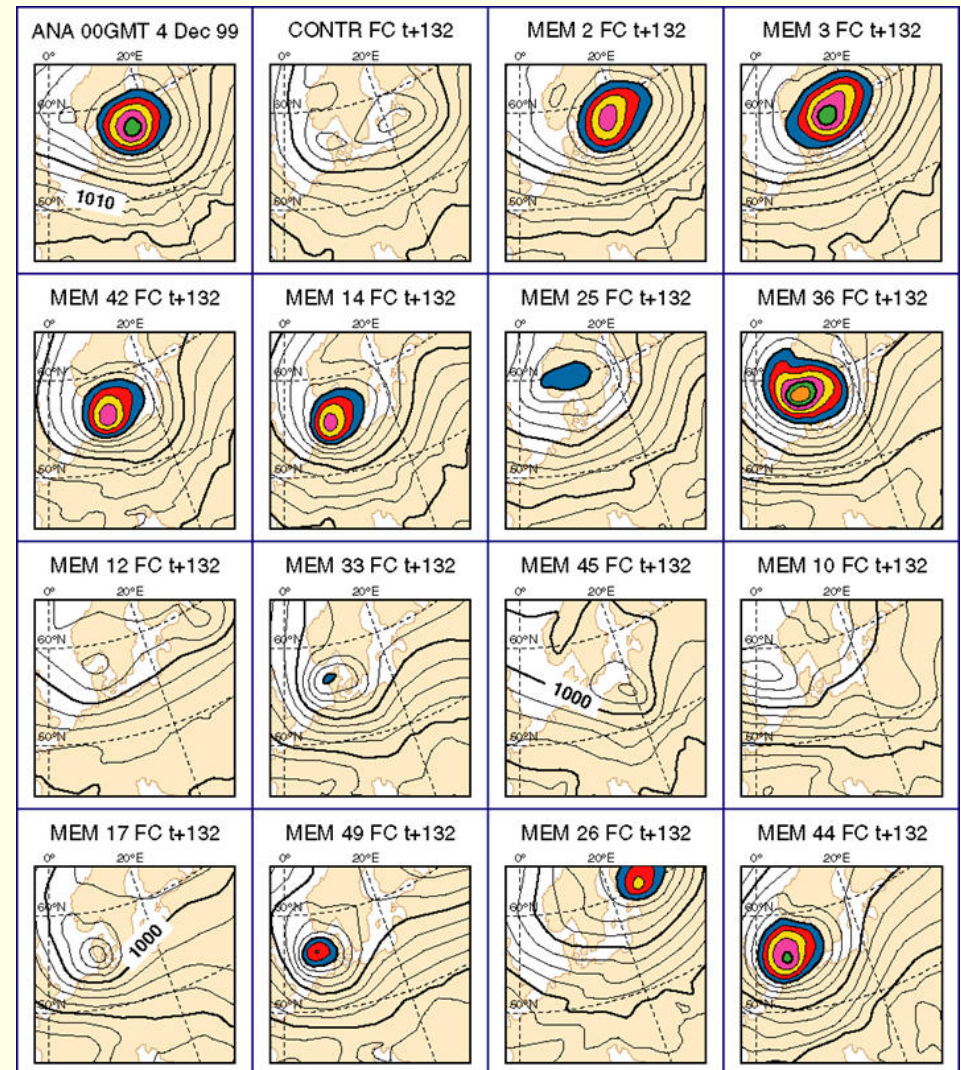



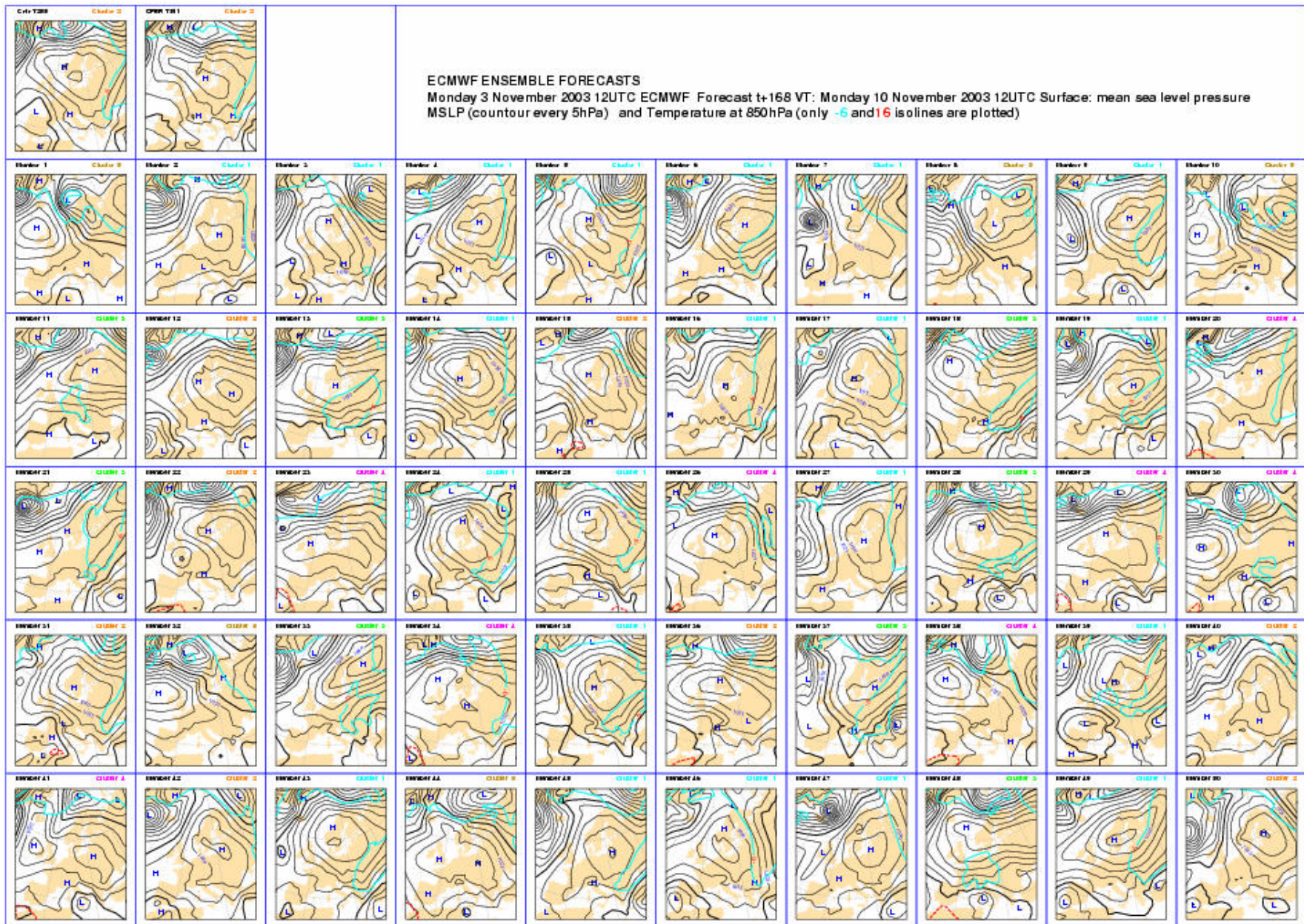

## Ensemble of fifty forecasts from ECMWF.

These products are produced routinely and used operationally in the member states.

The Seventh (and last) Reading

from **The Book of Limerick**



# The Seventh (and last) Reading from **The Book of Limerick**

If errors still bother you, Tough!  
**Uncertainty** is *The Right Stuff*.

# The Seventh (and last) Reading from The Book of Limerick

If errors still bother you, Tough!  
*Uncertainty* is *The Right Stuff*.  
It's anyone's guess,  
So use E-P-S,  
From **E-C-M-Double-you-uhf**.

**Thank you**